



Quick Reference Notes – **Daily Care**

簡易操作 - **日常保養**

ApeosPort - VII 5021 / 4021

CONTENTS

目錄

1	Clear Paper Jam 夾紙排解.....	2
1.1	Duplex Automatic Document Feeder / 自動雙面送稿裝置.....	2
1.2	Tray 1 and Tray 5/ 紙盤 1 及紙盤 5.....	3
2	Replacing Toner 更換碳粉匣.....	4

1 CLEAR PAPER JAM 夾紙排解

1.1 DUPLEX AUTOMATIC DOCUMENT FEEDER / 自動雙面送稿裝置

1. Open the document feeder left cover until it stops.

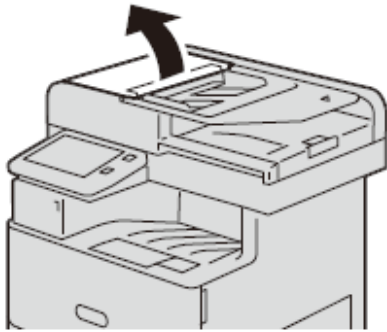

1. 向上拉起自動送稿裝置左蓋把手，將左蓋完全打開。

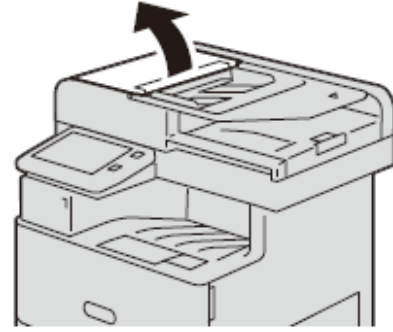

2. If the original is not caught in the entry of the document feeder, pull out the original.

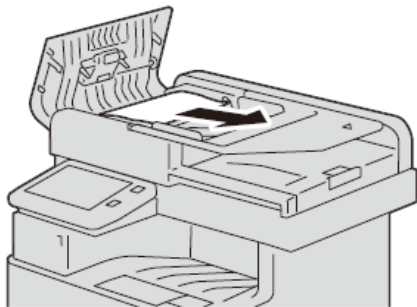

2. 若原稿並未卡在送稿裝置的入口，將原稿抽出。

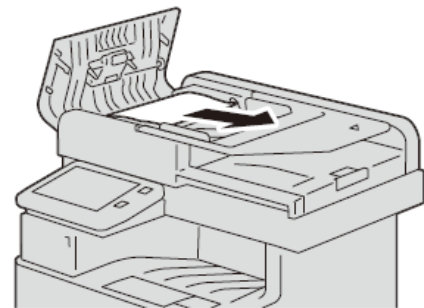

3. Make Sure that the original is not torn, wrinkled or folded, and then load the original again following the instructions displayed on the touch screen.

3. 確定原稿是否未撕破、起皺或摺疊，再依照觸控式顯示面板中的指示重新方入原稿。

1.2 TRAY 1 AND TRAY 5/ 紙盤 1 及紙盤 5

1. Remove any paper from the Tray 5.

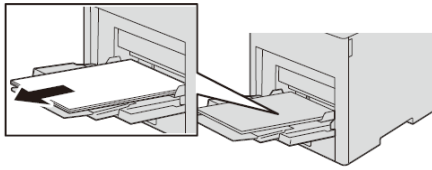

2. Pull Tray 5 out of the main unit.

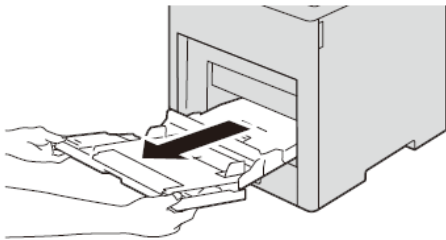

3. Pull Tray 1 out of the main unit.

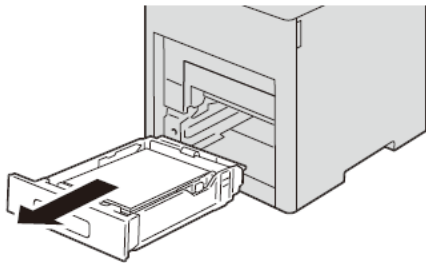

4. Remove any paper jammed in the device interior.

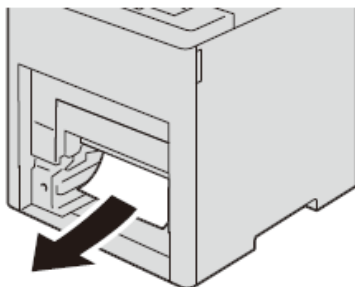

5. Insert Tray 1 and Tray 5 into the main unit completely.

1. 移除紙盤 5 上面的紙張。

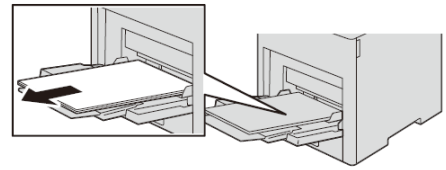

2. 把紙盤 5 從機身拉出。

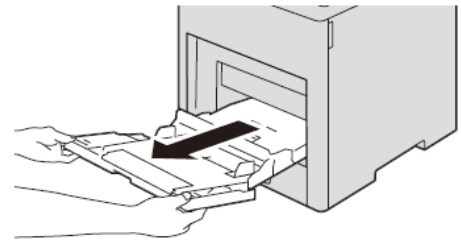

3. 把紙盤 1 從機身拉出。

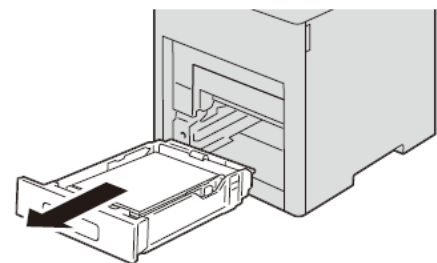

4. 把裝置內的卡紙移除。

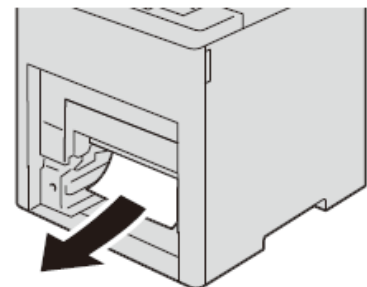

5. 把紙盤 1 及紙盤 5 正確插入機身內。

2 REPLACING TONER 更換碳粉匣

1. Make sure that the device is not operating, and open the front door.

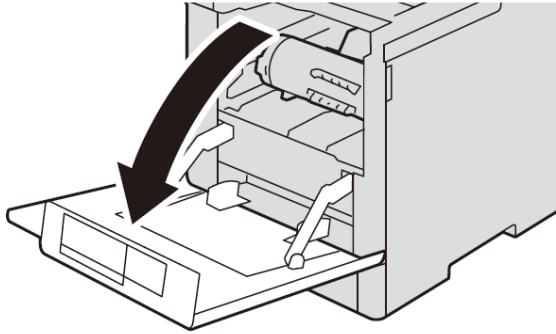

2. Pull out the toner cartridge slowly.

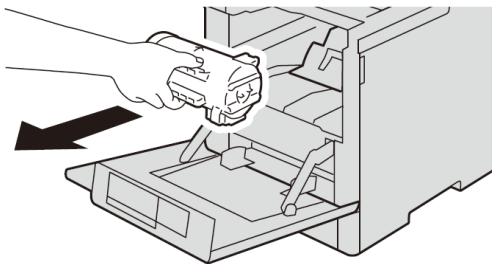

3. Shake the new toner cartridge gently.



4. Hold the cartridge with the arrow facing up, and insert the cartridge slowly.

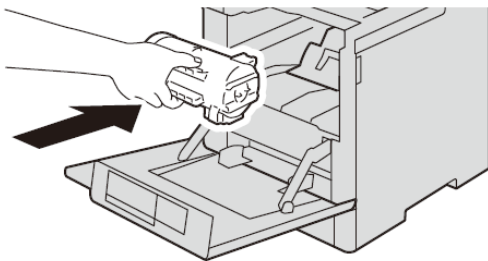

5. Close the front door.

1. 先確定裝置已經停止運作，然後開啟前蓋。

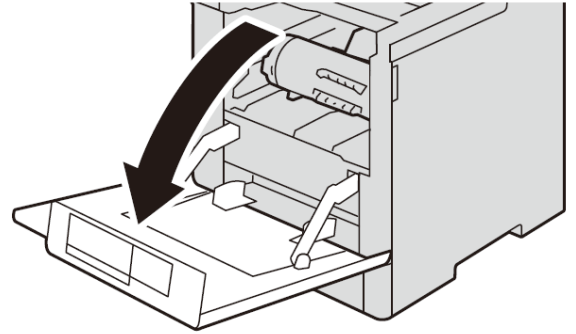

2. 慢慢拉出碳粉卡匣。

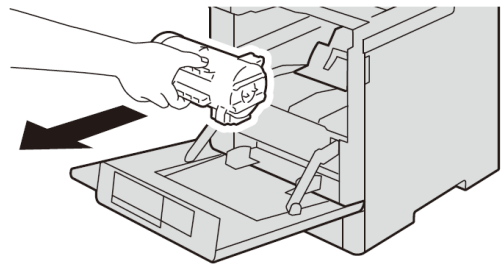

3. 輕輕搖晃新碳粉卡匣。



4. 把碳粉卡匣的箭咀標誌向上，然後慢慢地插入卡匣。

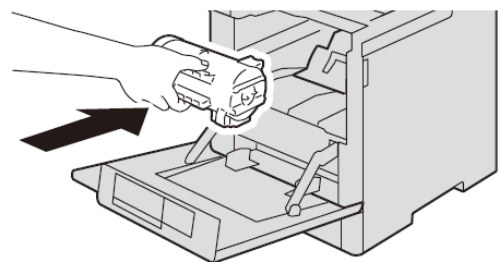

5. 關上前蓋。

Customer Support Center
2513-2513