



QUICK REFERENCE FOR ApeosPort® C3060 / C2060 / C2560



No. and Component

- 1 <Reset> button
- 2 <Power> button
- 3 <Home> button
- 4 Data indicator
- 5 <Jobs> button
- 6 Note on status display lamp
- 7 User Login

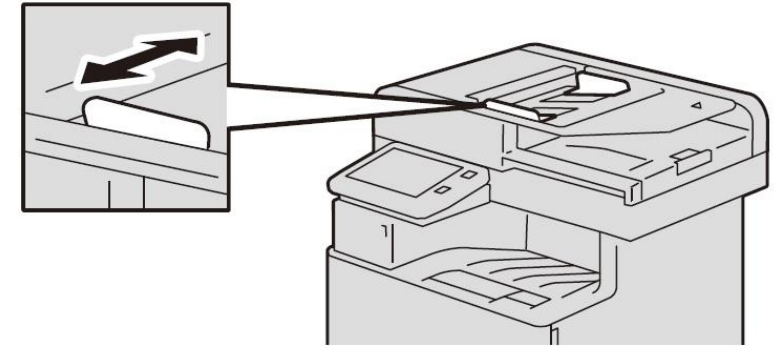

For assistance, please call 2513 2513.

Copy

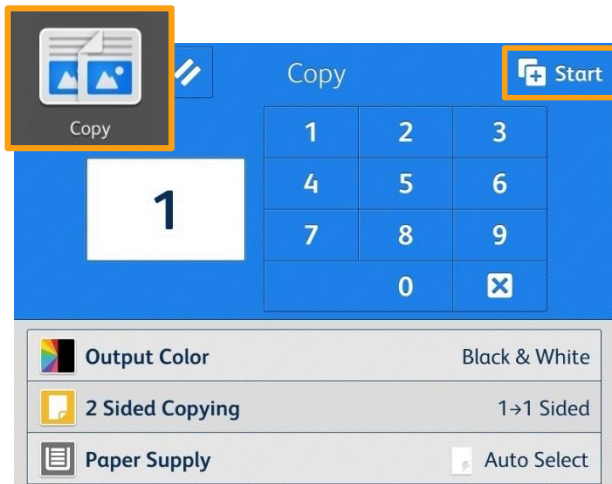

At [Copy] menu, select copy features, then press [Start].

Stop Copy

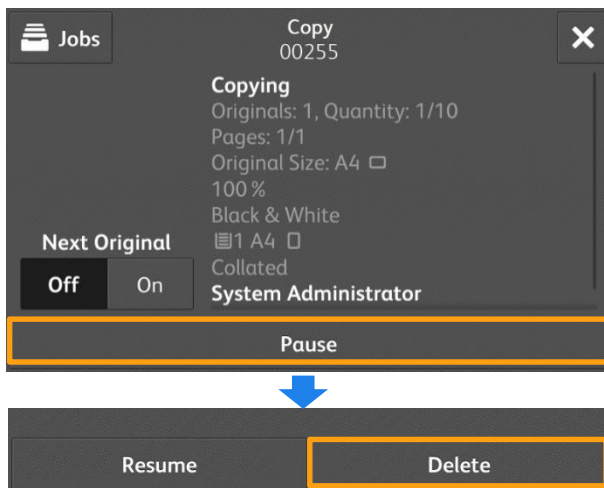

Select [Pause], then press [Delete].

Scan

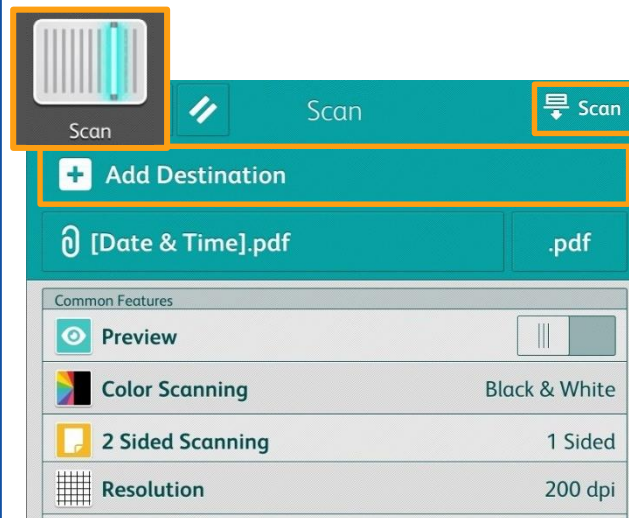

Select [Add Destination] to store the data in. Then select scan features and press [Scan].

Add Destination

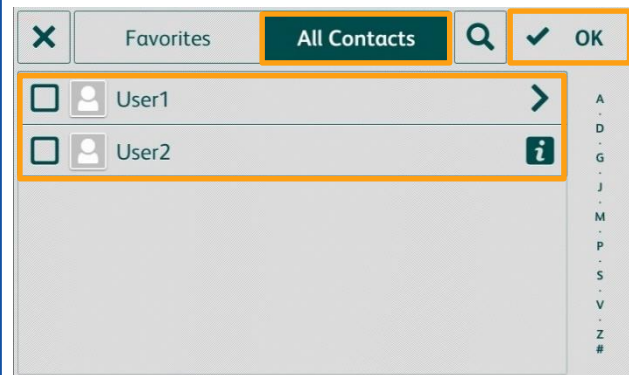

Select recipient from the [All Contacts] list. Click [OK], then select scan features and press [Scan].

Scan Auto

Scan Auto can skip the blank pages and rotate the pages into correct orientation automatically.

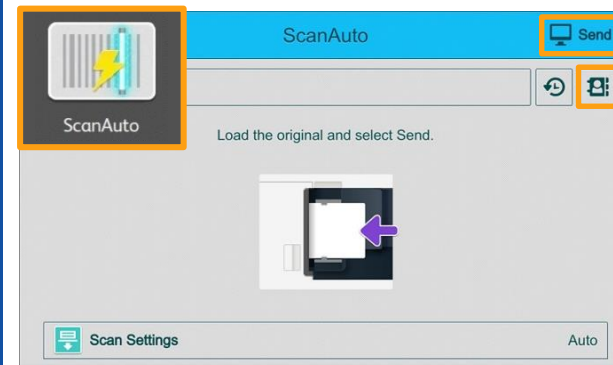

Select recipient from the [Enter] list, then press [Send].

Address Book



Select recipient from the [All Contacts] list.

Fax



Select recipient from the [Enter] list. Click [OK], then select fax features and press [Send].

Check Job Status

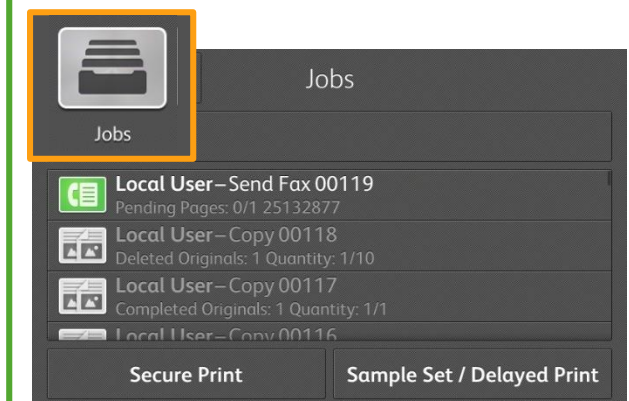

After fax transmission, select [Jobs] to verify the job completion status.