



For assistance, please call 2513 2513.

Apeos 5330 / 4830



No. and Component

- 1) <Power Saving> button
- 2) Jobs
- 3) <Home> button
- 4) Data indicator
- 5) Login / Out
- 6) Pins
- 7) Address Book

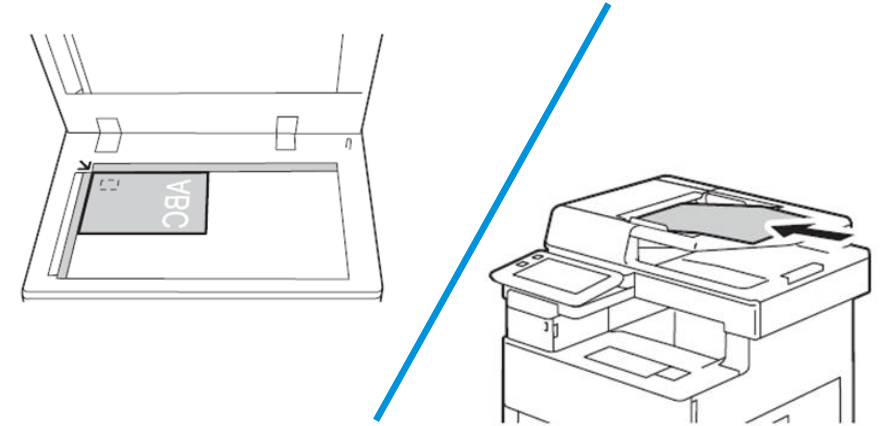

Copy

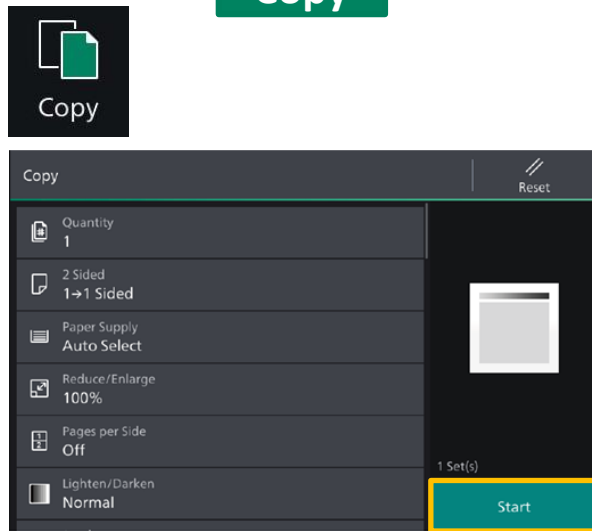

Configure the print quantity and the setting items. Tap on [Start].

Stop Copy

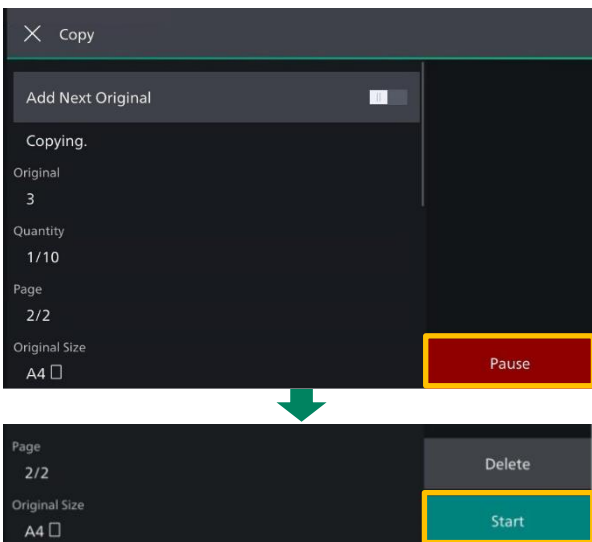

Tap on [Pause], then tap on [Delete].

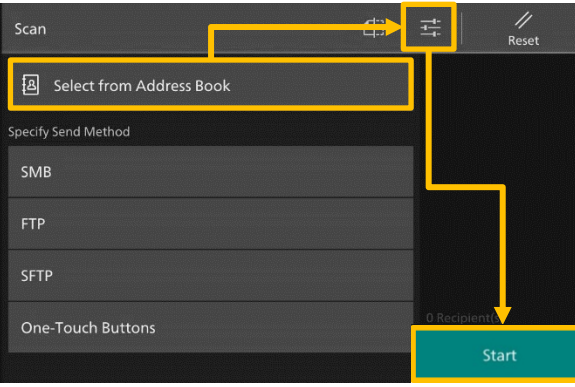

Specify the recipient by tapping on the [Address Book]. Configure the [Setting Items] and tap on [Start].

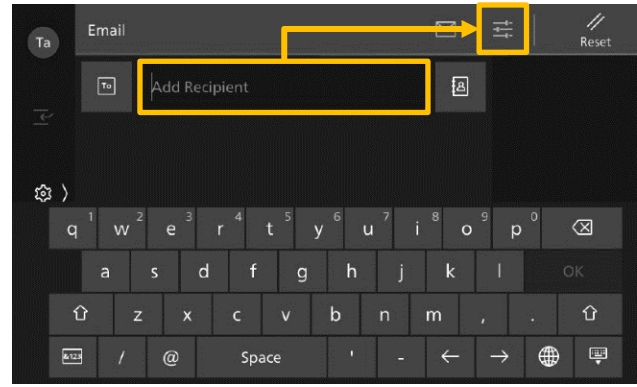
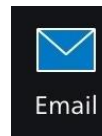

Specify recipient by using [Keyboard] or by tapping on the Address Book. Configure the [Setting Items] and tap on [Start].

Scan

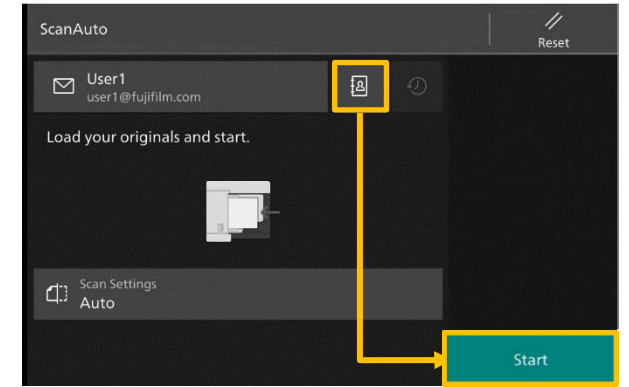
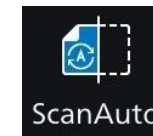

Specify recipient from [Scan Settings Auto], then tap on [Start].

Scan Auto skip the blank pages and rotate the pages into correct orientation automatically.

Fax

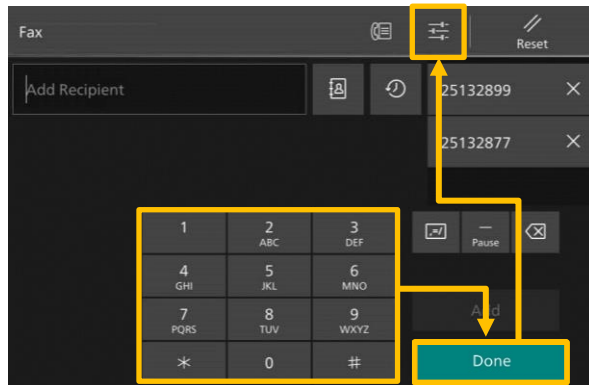
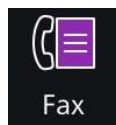

Enter the recipient with the [Keyboard] and tap on [Done]. Configure the [Setting Items] and tap on [Start].

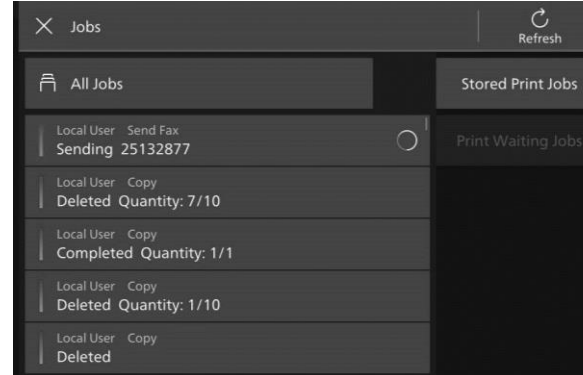

After fax transmission, tap on [Jobs] to verify the job completion status.

You can check active jobs (both running and waiting) and completed jobs.

Enquiry

Scan QR Code for more instruction.



Visit below website for more online support.
<https://support-fb.fujifilm.com>