



Quick Reference Notes - COPY

簡易操作 - 複印

Apeos 7580 / 6580

CONTENTS

目錄

1	Copy Procedure 複印步驟	1
1.1	Loading Documents 放置原稿.....	1
1.1.1	Document Feeder 自動送稿裝置.....	1
1.1.2	Document Glass 玻璃面板	1
1.2	Selecting Features (Copy) 選擇功能 (複印).....	2
1.3	Entering The Quantity 輸入複印份數	3
2	Basic Copy Features 基本複印功能.....	4
2.1	2 Sided Copying 雙面/單面選擇.....	4
2.2	Paper Supply 紙張選擇.....	5
2.2.1	Tray 5 (Bypass) 紙盤 5 (手送紙盤)	6
2.3	Pages Per Side 多張合一 (N 合 1).....	7
2.4	Copy Output 分頁/不分頁.....	8
2.5	Staple (Optional) 裝訂(額外購置)	9
2.6	Hole Punch (Optional) 打孔(額外購置).....	10
2.7	Original Type 原稿類型	11
2.8	Copy (ID Card) ID 卡複印	12
2.9	Non-Standard Size Original 規格以外的原稿尺寸	13
2.10	Operations During Copying 複印期間的操作	15
2.10.1	Stopping the Copy Job 停止複印.....	15
2.10.2	Loading the Next Document 放置下一份原稿	16
2.10.3	Interrupting the Copy Job 插印作業.....	17

Scan QR Code OR Click [here](#) for more instruction.

請掃描 QR Code 或者點擊[這裡](#)查看更多使用說明。

For more online support information please visit

更多相關資料，請訪問以下網址：

<https://support-fb.fujifilm.com>



1 COPY PROCEDURE 複印步驟

1.1 LOADING DOCUMENTS 放置原稿

1.1.1 Document Feeder 自動送稿裝置

1. Confirm that the document is free of tag paper, adhesive tape, staples, and clips, and stretch out the document if it is wrinkled or folded.
 2. Align the upper left corner of the document so that the original size is correctly detected.
 3. Load the document face up (when the document is 2-sided, place the front side up) in the center of Document Feeder.
1. 確認原稿上沒有便利貼、膠帶、釘書針或萬字夾等物品，並將有皺褶的原稿確實整平。
 2. 對齊原稿左上角，以便正確偵測原稿尺寸。
 3. 讀取面(雙面原稿時則為正面)朝上，並放置於送稿裝置的中央。

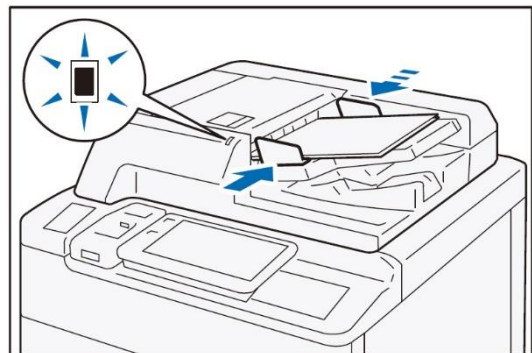
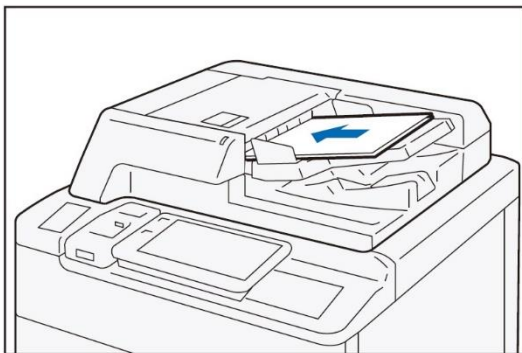

1.1.2 Document Glass 玻璃面板

1. Open the Document Cover.
 2. Load the document face down with the document aligned with the upper left corner of the Document Glass.
1. 打開原稿蓋。
 2. 將掃描面朝下，並對齊玻璃面板的左上角來放置原稿。

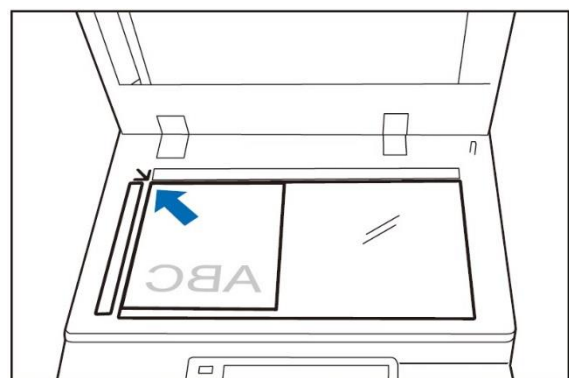
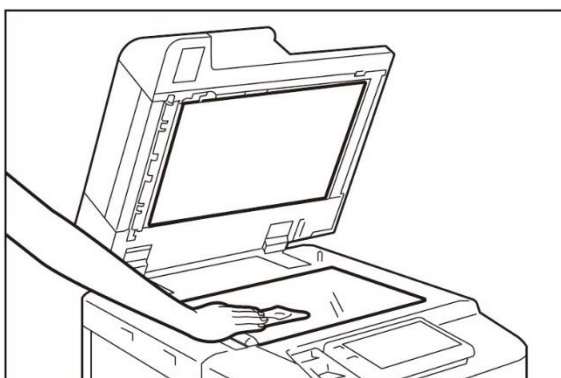

1.2 SELECTING FEATURES (COPY) 選擇功能 (複印)

1. Press the Home button.

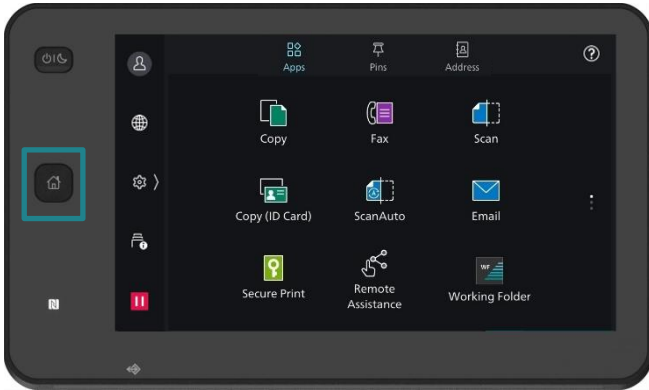

1. 按一下首頁按鈕。



2. Tap on [Copy].

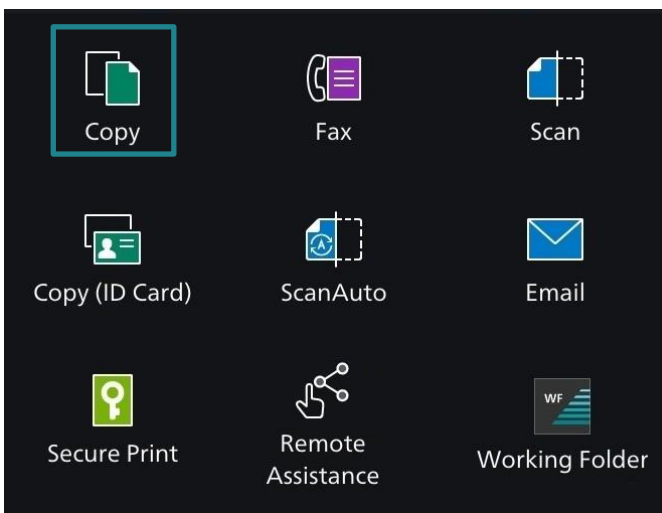

2. 點選【複印】。



3. Configure necessary features.

4. Tap on [Start] to copy.

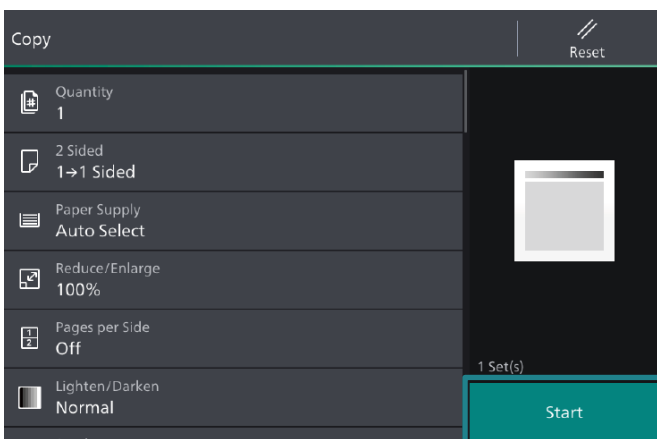

3. 設置所需功能。

4. 點選【啟動】開始複印。

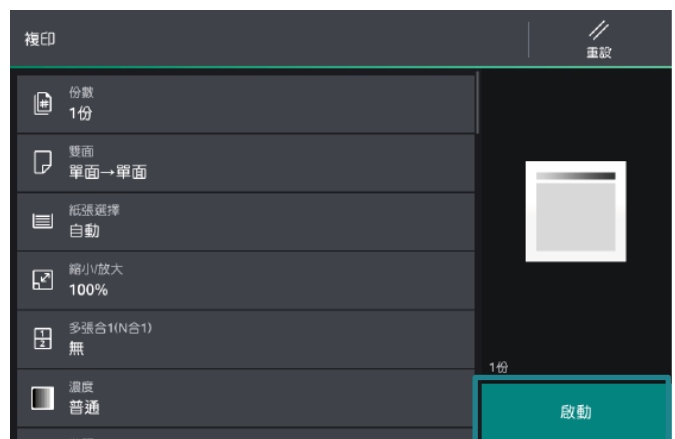

1.3 ENTERING THE QUANTITY 輸入複印份數

1. Tap on [Quantity].

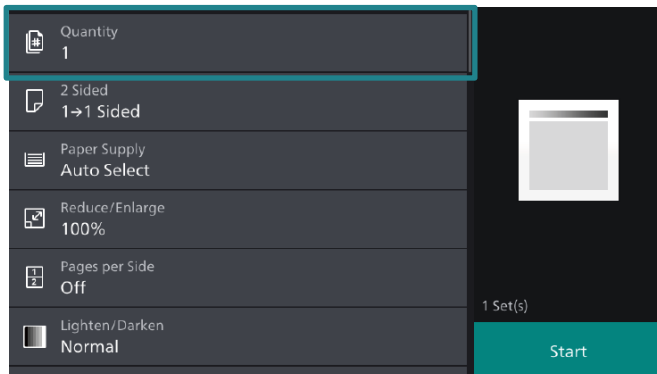

1. 點選【份數】。

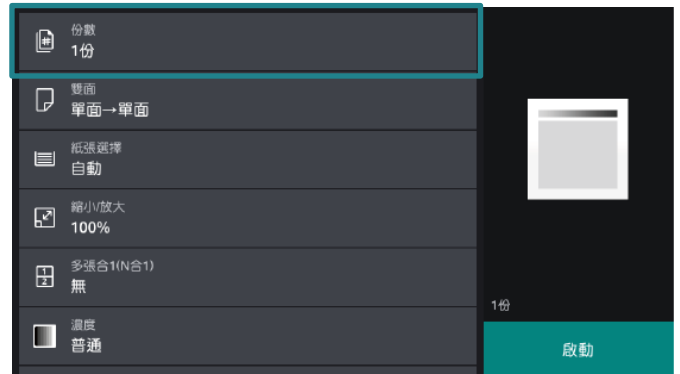

2. Entering the number of copies.

2. 輸入複印份數。

3. Tap on [Start].

3. 點選【啟動】。

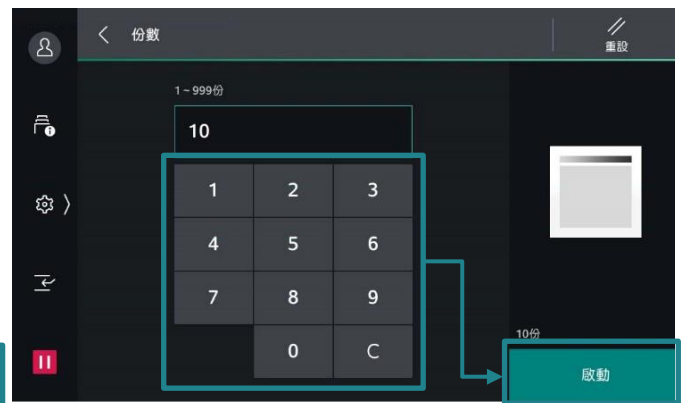
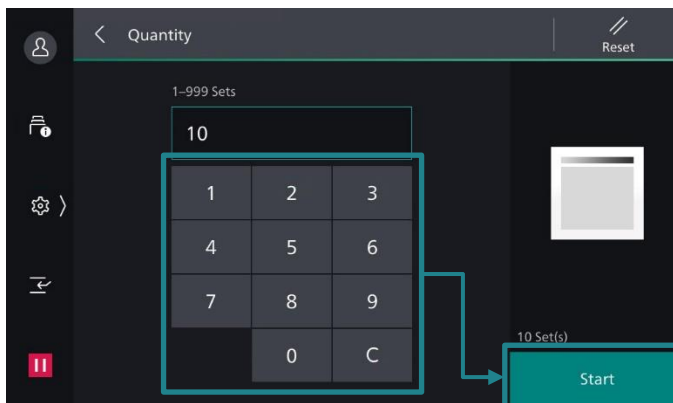

If you have entered an incorrect value, press **C** and enter the correct value.

如輸入錯誤數值，按 **C** 並輸入正確的數值。

Note: You can enter up to 999 for the number of copies.

補充：最多可輸入 999 複印數。

2 BASIC COPY FEATURES 基本複印功能

2.1 2 SIDED COPYING 雙面/單面選擇

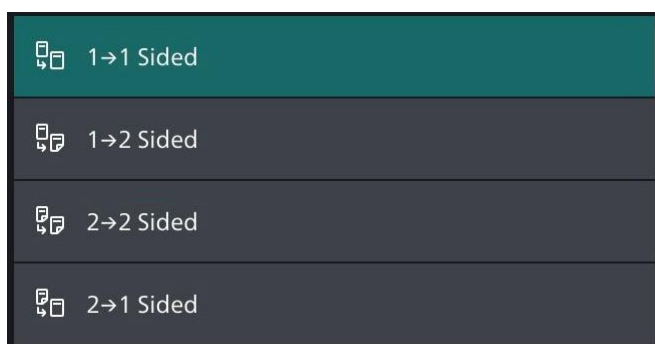
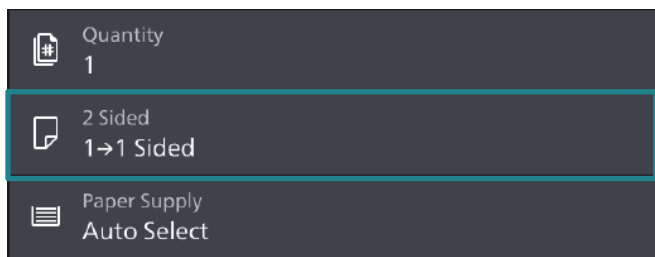

1→1 Sided

Makes a copy of a 1-sided document on one side of the paper.

1→2 Sided

Makes a copy of a 1-sided document on both sides of the paper.

2→2 Sided

Makes a copy of a 2-sided document on both sides of the paper.

2→1 Sided

Makes a copy of a 2-sided document on one side of the paper.

Head to Head

Select this option when you want the orientation of the front and back sides of the copy to be the same as that of the document.

Head to Toe

Select this option when you want the orientation of the front and back sides of the copy to be the opposite of that of the document.

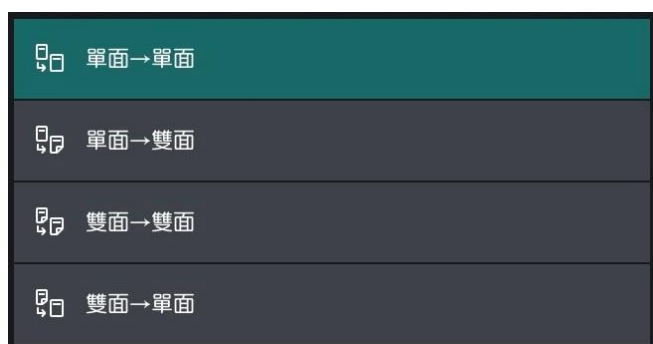
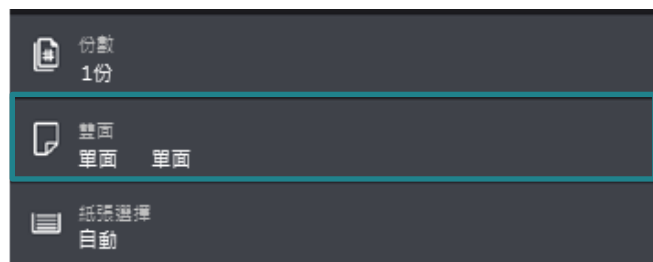

單面→單面

將單面原稿複印於紙張的單面。

單面→雙面

將單面原稿複印於紙張的兩面。

雙面→雙面

將雙面原稿複印於紙張的兩面。

雙面→單面

將雙面原稿複印於紙張的單面。

左右對開

當您希望複本的正面和反面的方向與文件方向相同時，請選擇此項。

上下對開

當您希望複本的正面和反面的方向與文件方向相反時，請選擇此項。

2.2 PAPER SUPPLY 紙張選擇

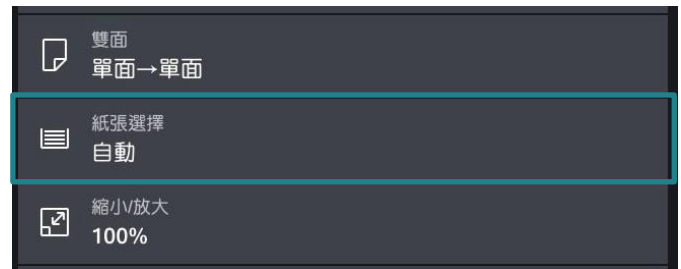
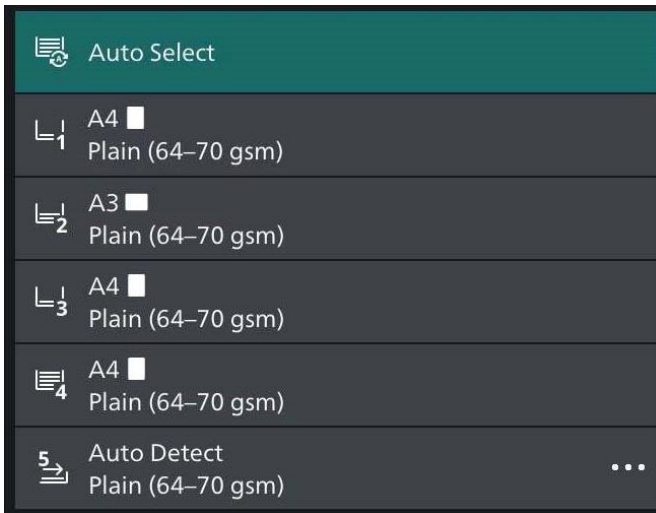
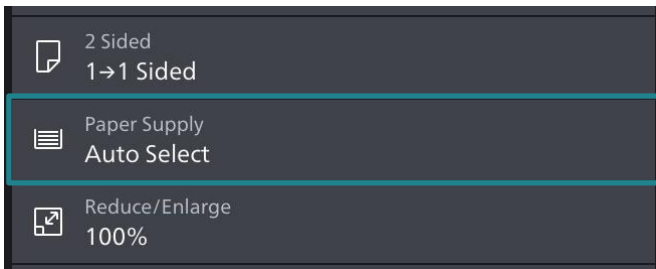

Auto

The paper type of all the trays are default as plain paper. If one tray is out of paper, it will select another tray with the same paper size automatically.

Note: If the original size is different from the paper tray, you must select the tray.

自動

所有紙盤的紙張類型預設為普通紙，如果一個紙盤缺紙，則會自動選擇相同紙張尺寸的紙盤。

注意：如果原稿尺寸與紙盤的紙張尺寸不同，則必須選擇紙盤。

2.2.1 Tray 5 (Bypass) 紙盤 5 (手送紙盤)

If you want to make copies on paper that cannot be loaded in Tray 1, use Tray 5 (Bypass).

1. Tap on [Tray 5] from [Paper Supply] screen.

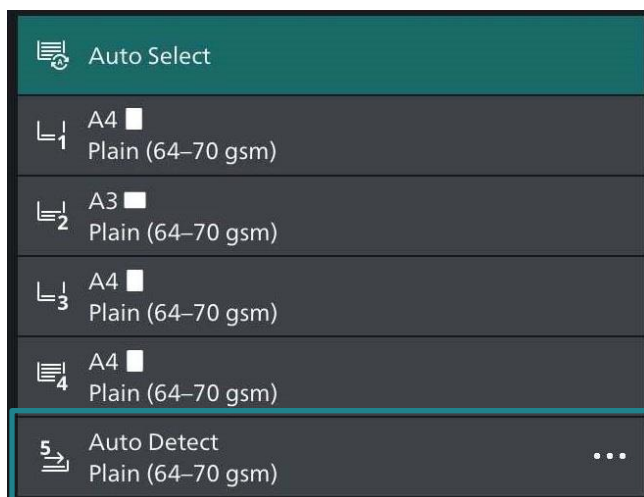

2. Load paper with the side to be copied or printed on facing downward. Insert the paper until its edge lightly touches against the paper feed entrance.

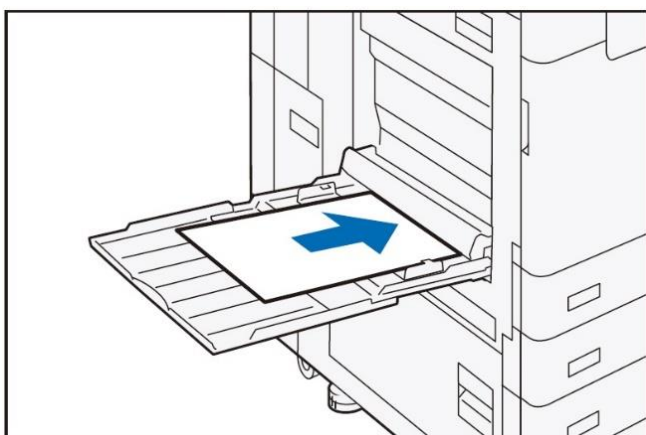

無法置入紙盤 1 的紙張，請置入紙盤 5 (手送紙盤) 進行複印。

1. 於【紙張選擇】畫面，點選【紙盤 5】。



2. 放置紙張，要複印或列印的一面朝下，將紙張輕輕插入紙張進紙入口處。

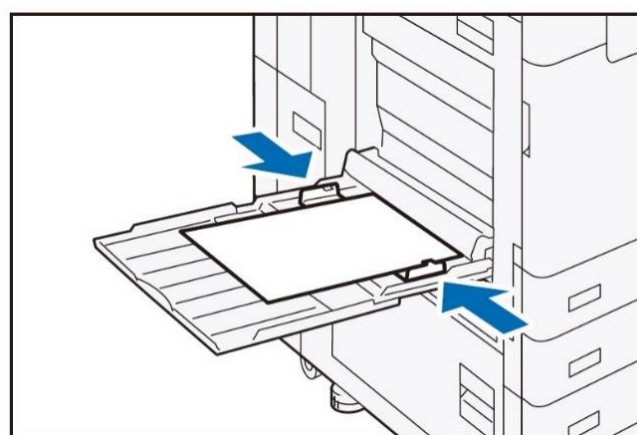

2.3 PAGES PER SIDE 多張合一 (N 合 1)

This feature allows you to copy two, four, or eight pages of a document together onto a single sheet of paper.

此功能可將 2 頁、4 頁或 8 頁複印在同一張紙上。

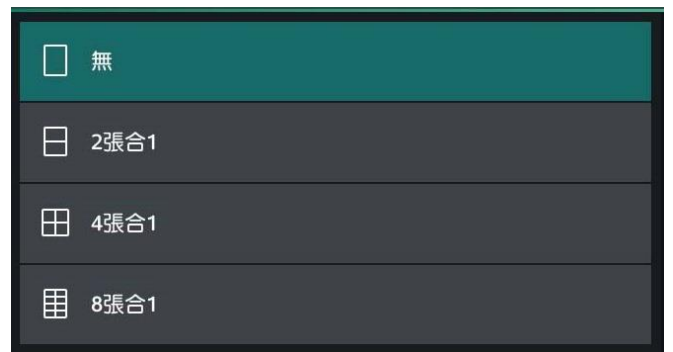
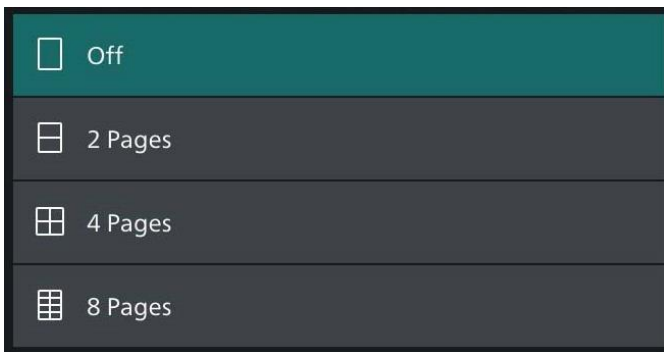
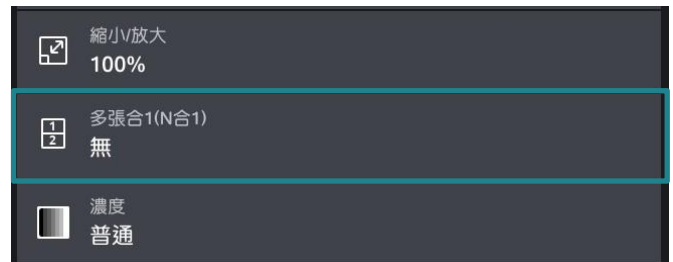
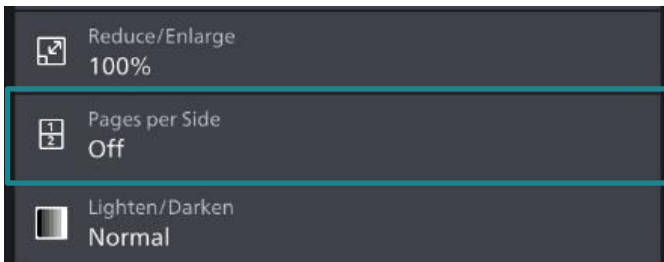

2 Pages

Two pages are copied together onto a single page.

4 Pages

Four pages are copied together onto a single page.

8 Pages

Eight pages are copied together onto a single page.

2 張合 1

將 2 張原稿複印於同一張紙上。

4 張合 1

將 4 張原稿複印於同一張紙上。

8 張合 1

將 8 張原稿複印於同一張紙上。

2.4 COPY OUTPUT 分頁/不分頁

Set the order for outputting the paper.

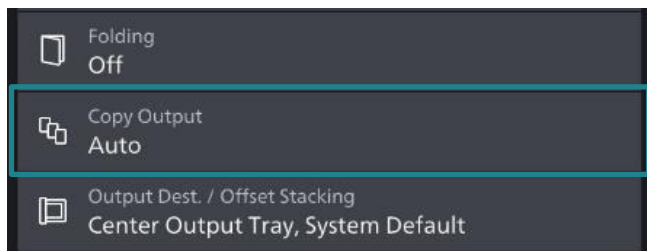

Auto

Copies are output collated when using auto document feeder.

Collated

The machine outputs sheets sorted into sets that are arranged in page order.

Uncollated

The machine outputs the specified number of copies and sorts sheets by page.

Uncollated with Separators

The machine outputs copies with inserting blank sheets as a separator and sorts sheets by page.

設定輸出紙張的次序。

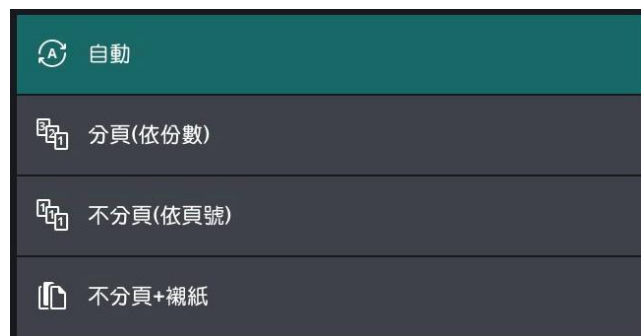

自動

當原稿放置在送稿裝置中時，複本將分頁。

分頁 (依份數)

本機會依頁面順序分頁輸出整份複本。

不分頁(依頁號)

本機會輸出指定的複本數量，並依頁面順序排序。

不分頁+襯紙

本機會在輸出的複本中插入空白紙作為襯紙，並按照頁面順序排序。

2.5 STAPLE (OPTIONAL) 裝訂(額外購置)

This feature allows you to set the position for stapling.

此功能可供您選擇裝釘的位置。

Note: This feature is optional.

注意：需額外購置。

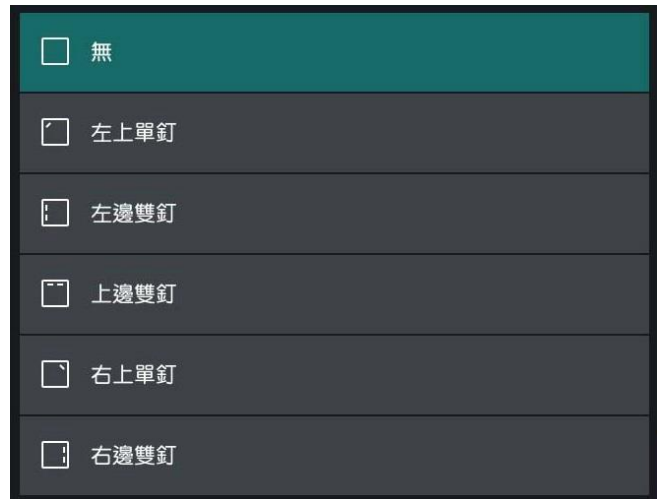
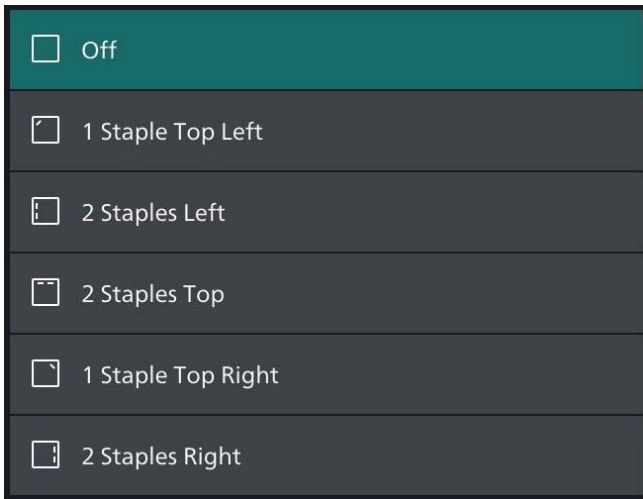
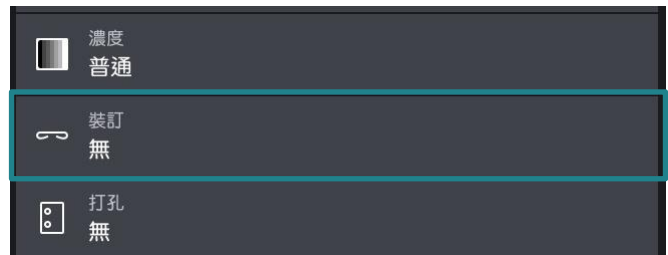
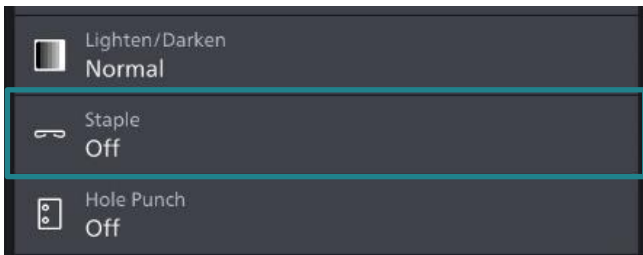

Staple - The number of sheets that can be stapled is 2 - 50. (when 80 gsm paper is used).

裝釘 – 可裝釘的張數為 2-50 張 (使用 80 gsm 紙張時)。

2.6 HOLE PUNCH (OPTIONAL) 打孔(額外購置)

This feature allows you to set the position of the hole punch.

此功能可供您選擇打孔的位置。

Note: This feature is optional.

注意：需額外購置。

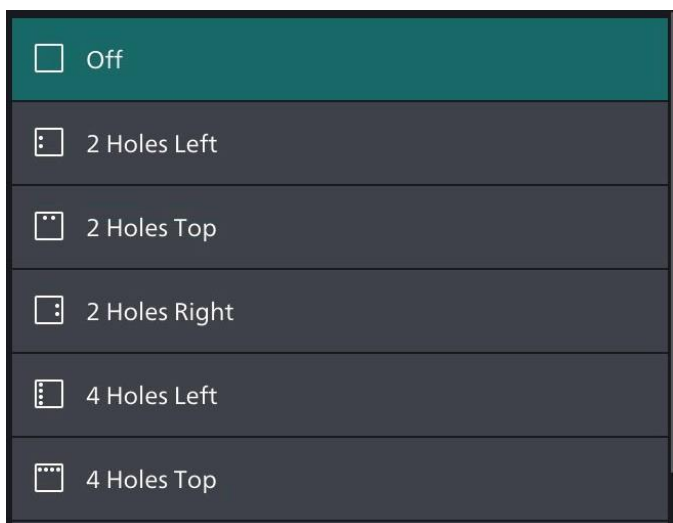
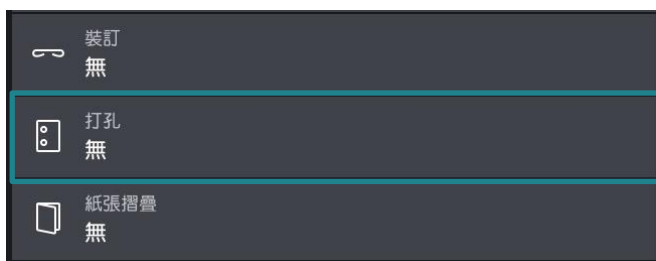
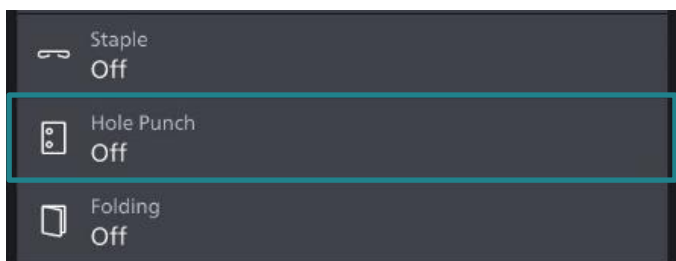

Hole Punch – 2 holes or 4 holes is available for selection.

打孔 – 兩孔或四孔可選擇。

2.7 ORIGINAL TYPE 原稿類型

This feature allows you to select the type of documents, such as text and photos. By selecting a document type, you can make copies at optimum image quality.

1. Tap on [Original Type].

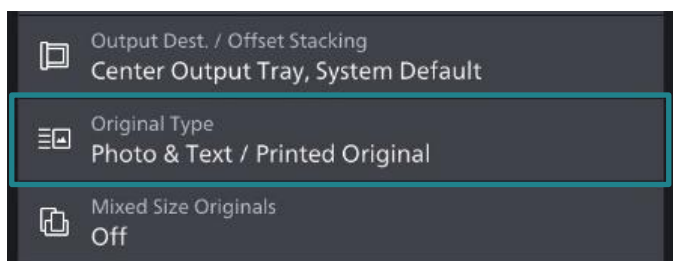

2. Tap on [Photo & Text].

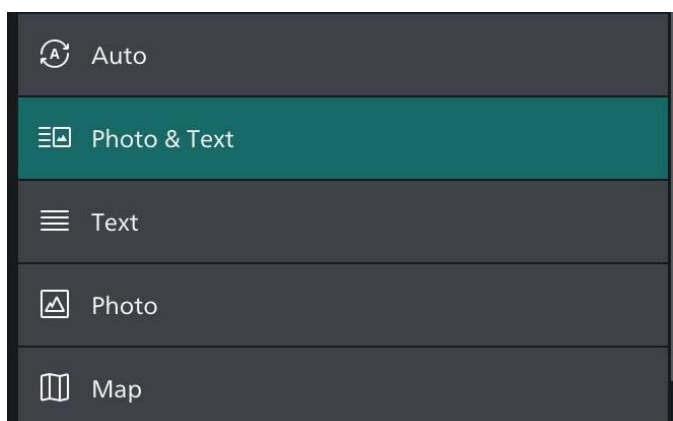
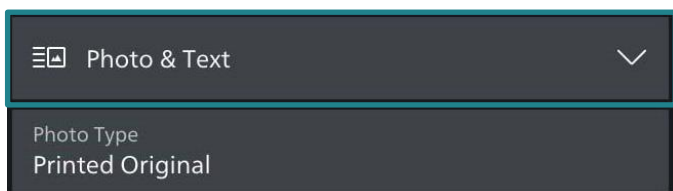

Photo & Text

Select this option when the document contains both text and photos.

Text

Select this option to make copies of text.

Photo

Select this option to make copies of photos.

此功能可供您選擇文件種類，例如文字和照片。藉由選擇文件種類，您可使用最理想的畫質進行複印。

1. 點選【原稿類型】。

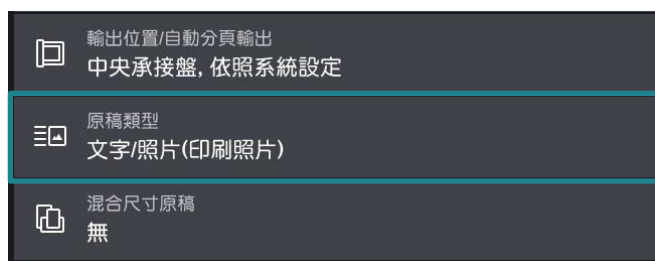

2. 點選【文字/照片】。

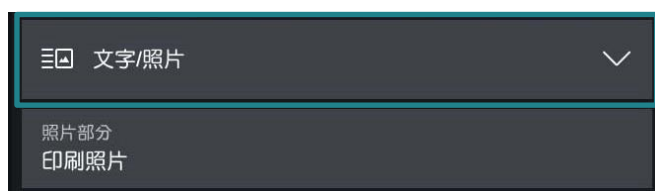

文字/照片

文件包含文字和照片時，請選擇此選項。

文字

複印文字原稿時，請選擇此選項。

照片

複印照片時，請選擇此選項。

2.8 COPY (ID CARD) ID 卡複印

This feature allows you to copy both sides of a small undetectable original, such as an ID card, onto one side of paper.

此功能可供您將無法偵測的小型文件 (如身份證) 的正背面複印至同一面紙張上。

1. Tap on [Copy (ID Card)].

1. 點選【ID 卡複印】。

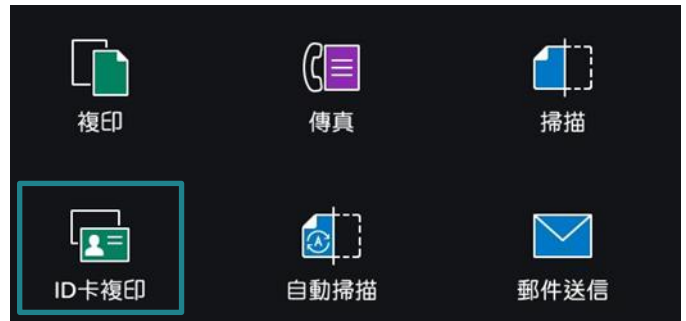
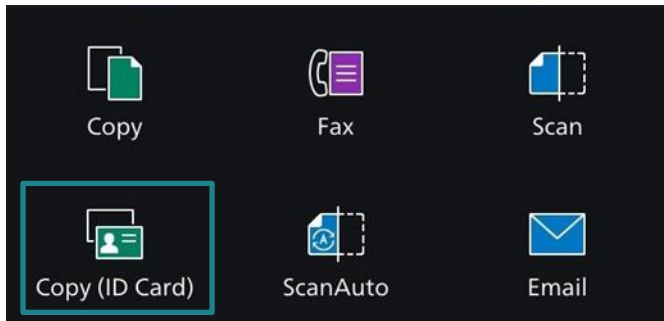

2. Place the ID Card on document glass, then tap on [Start], copy the front side of the card as usual.

2. 放置文件於玻璃面板，然後點選【啟動】，如常複印文件的正面。

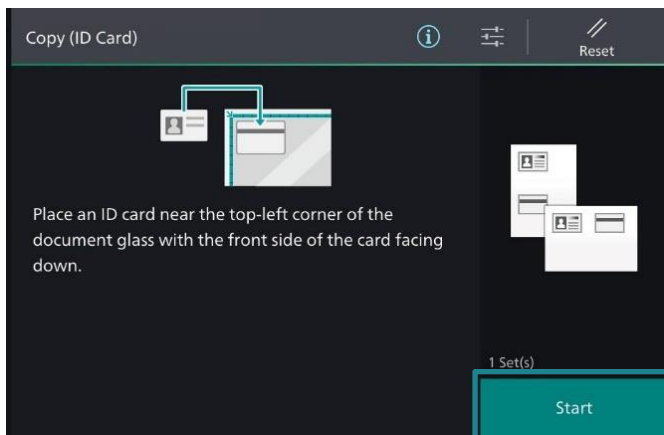

3. Turn the card over without changing its position and tap on [Scan] to copy the back side of the card.

3. 翻轉文件於正面相同位置上，點選【啟動】複印文件的背面。

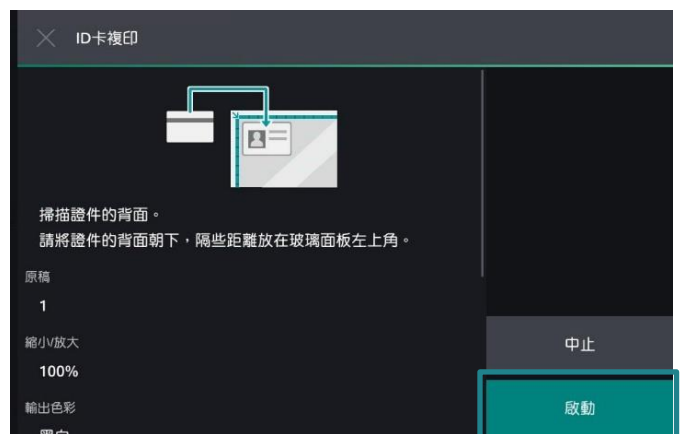
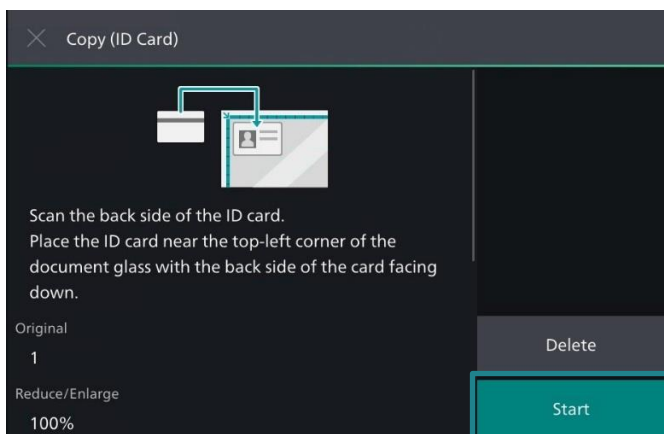

2.9 NON-STANDARD SIZE ORIGINAL 規格以外的原稿尺寸

When a document is of non-standard size, and the output needs fit to the paper size, follow the steps below.

1. Tap on [Reduce / Enlarge], and then choose [Auto].

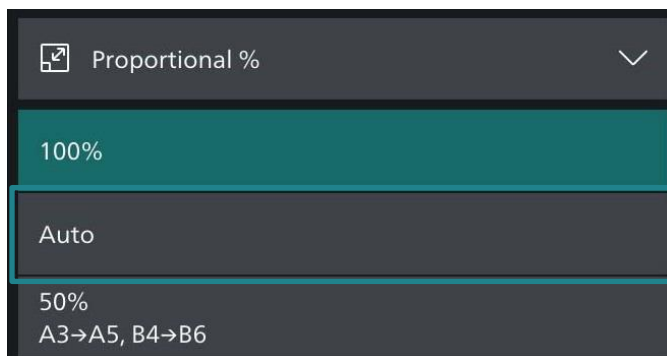
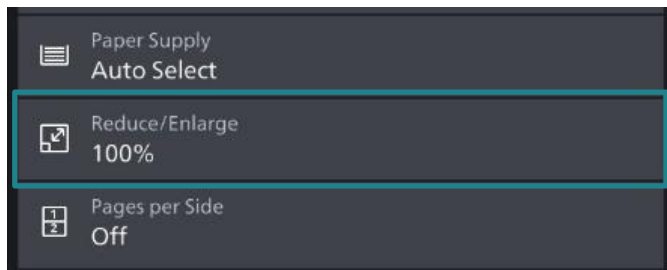

2. Tap on [Paper Supply], and then choose the tray you need.

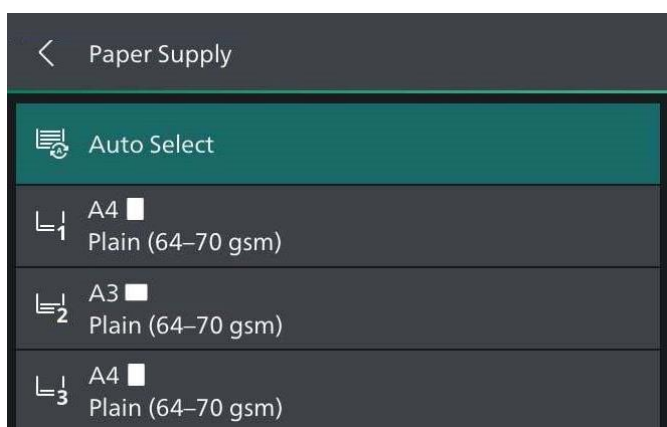
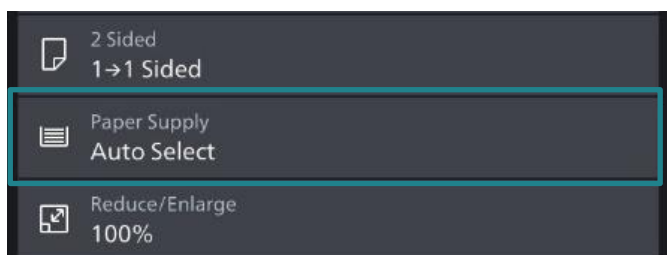

當文件為規格以外的尺寸，而複本需要符合紙盤的紙張大小時，請根據以下操作。

1. 點選【放大/縮小】，然後選擇【自動】。

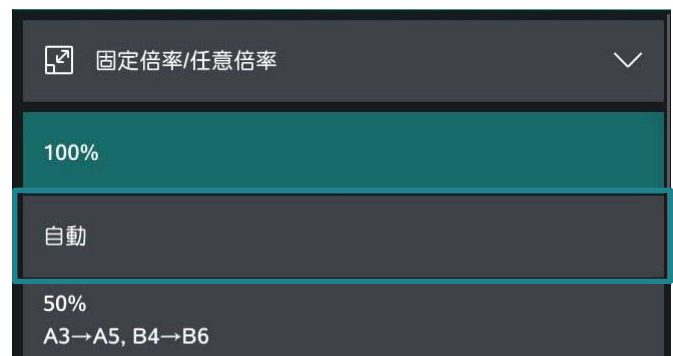
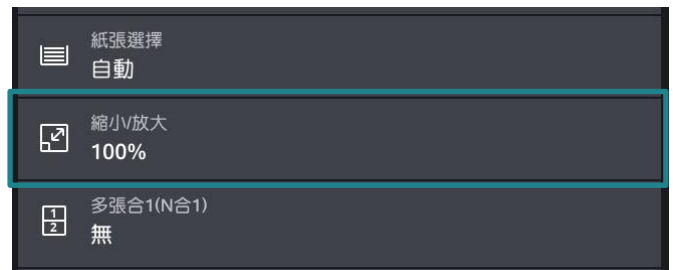

2. 點選【紙張選擇】，然後選擇所需紙盤。

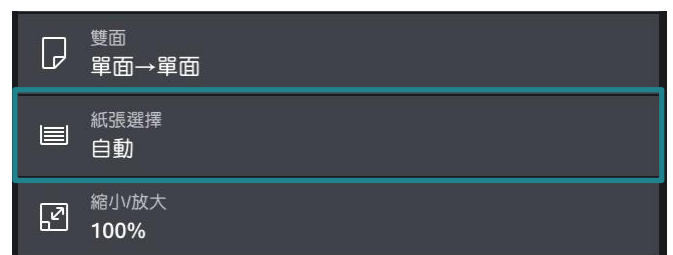

3. Tap on [Original Size].

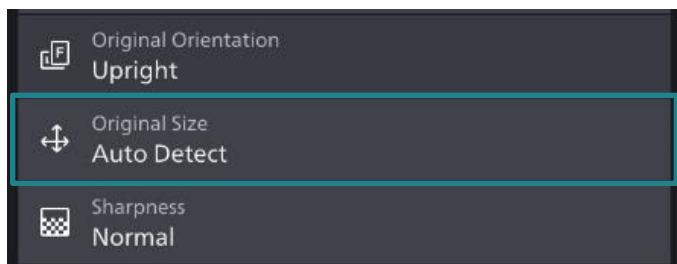

3. 點選【原稿尺寸】。

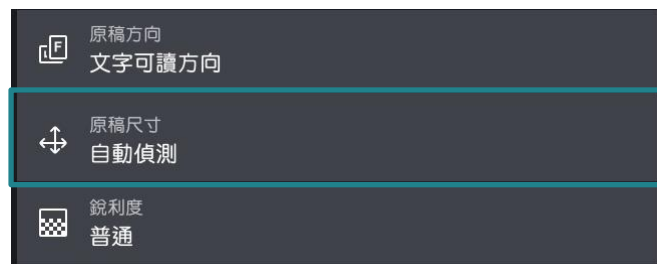

4. Tap on [Auto Detect / Standard Size].
Then tap on [Custom Size].

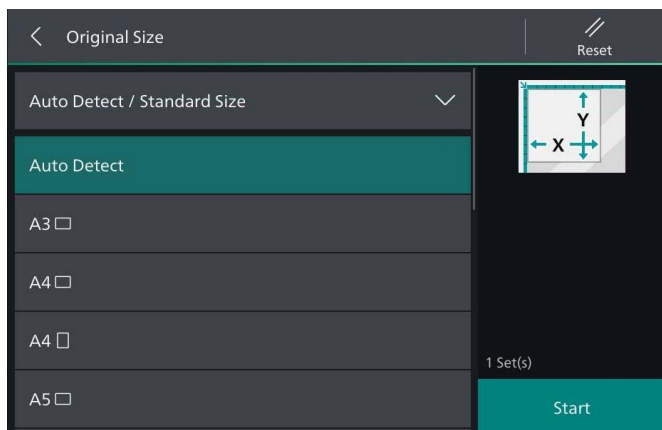

4. 點選【自動 / 規格尺寸】，再點選【自訂尺寸】。

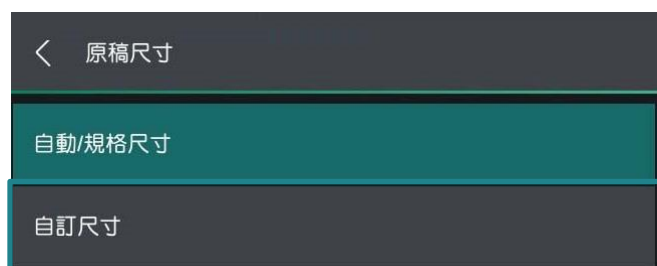
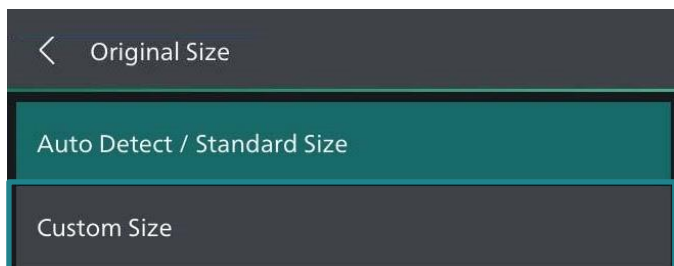
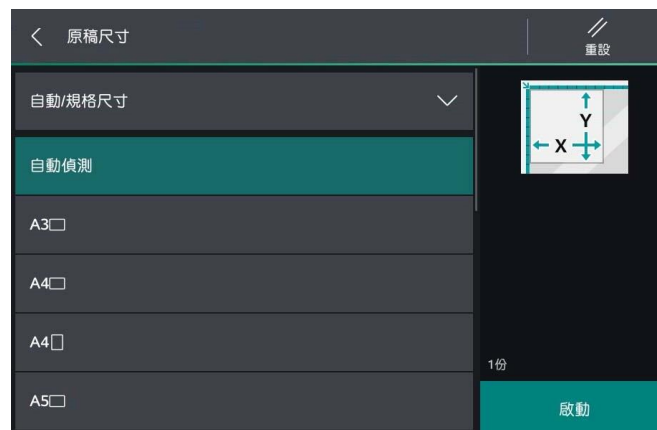

5. Specify values for the X and Y dimensions,
then select [Start].

5. 輸入橫向和縱向的數值然後選【啟動】。

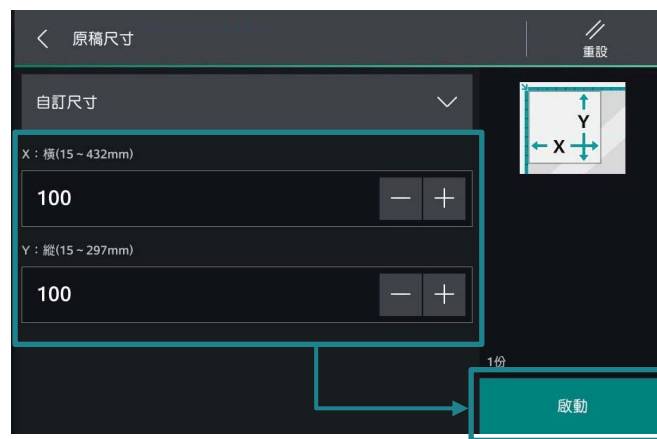
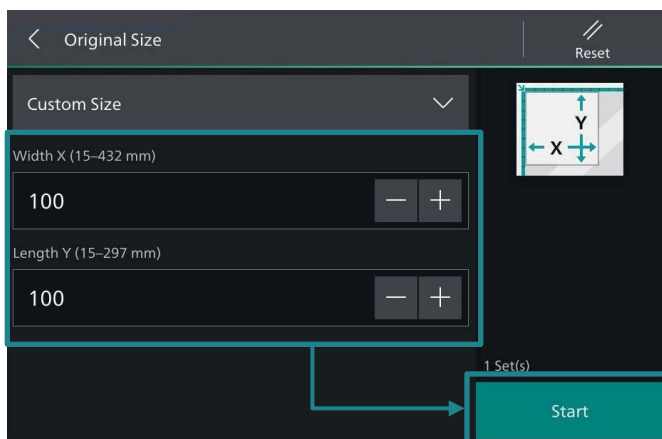

Note: The original orientation must be as same as that of the output tray.

注意：原稿放置方向必須與選擇紙盤一致。

2.10 OPERATIONS DURING COPYING 複印期間的操作

2.10.1 Stopping the Copy Job 停止複印

1. Tap on [Pause] on the touch screen.

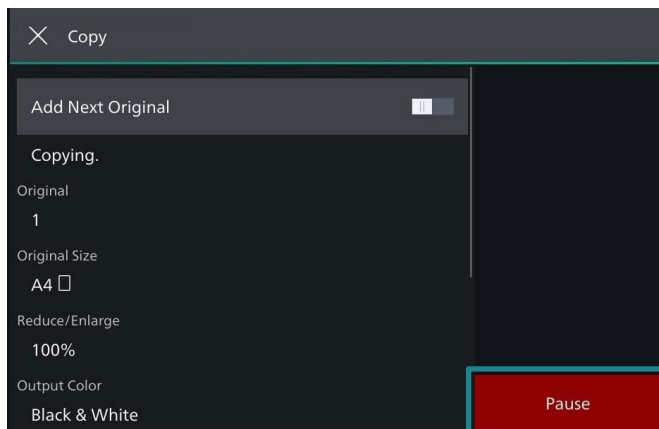

1. 在觸控屏幕上點選【停止】。

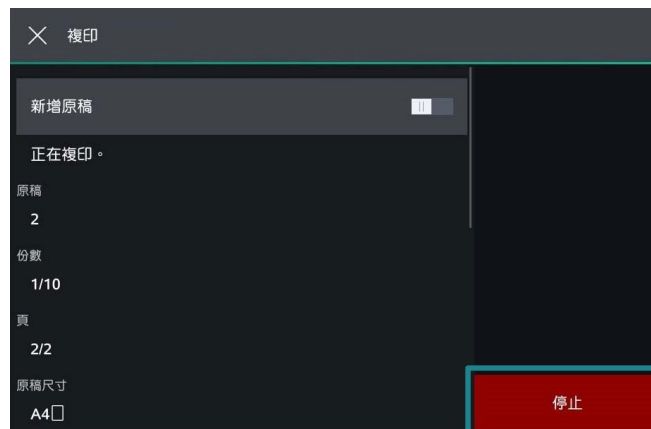

2. Tap on [Delete] on the touch screen.

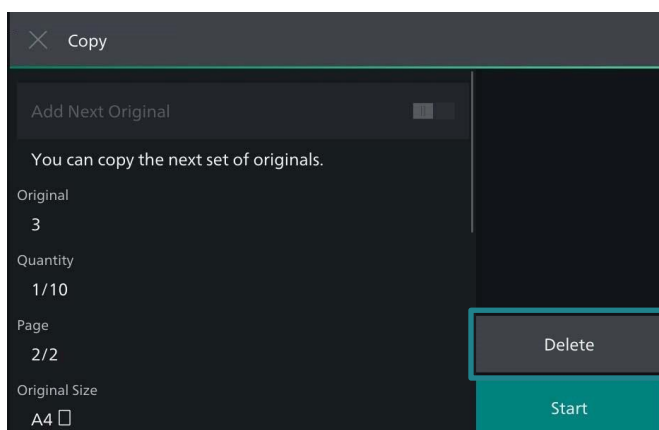

2. 在觸控屏幕上點選【中止】。

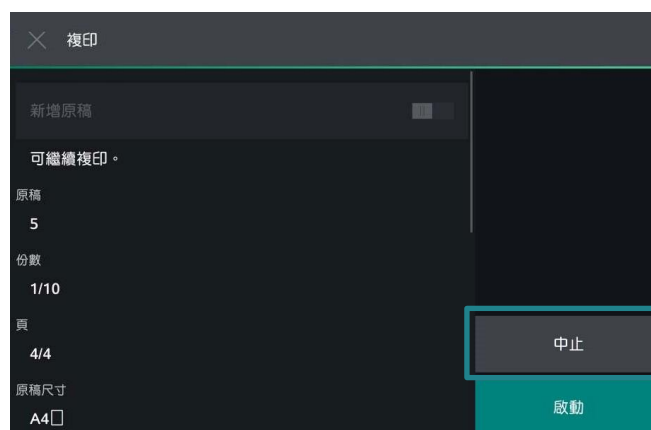

2.10.2 Loading the Next Document 放置下一份原稿

If you have more documents to copy, select [Add Next Original] on the touch screen while the current document is being scanned. This allows you to scan the documents as a single set of data.

1. Select  while scanning is in progress.

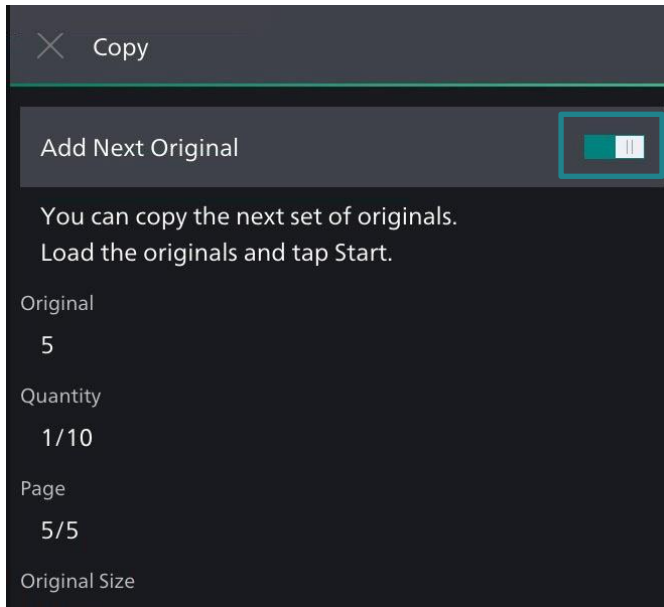

若還有其他文件要影印，請在掃描文件時在觸控式顯示面板上選擇【新增原稿】，如此可將文件視為一份資料而進行掃描。

1. 請在掃描進行期間選擇 。

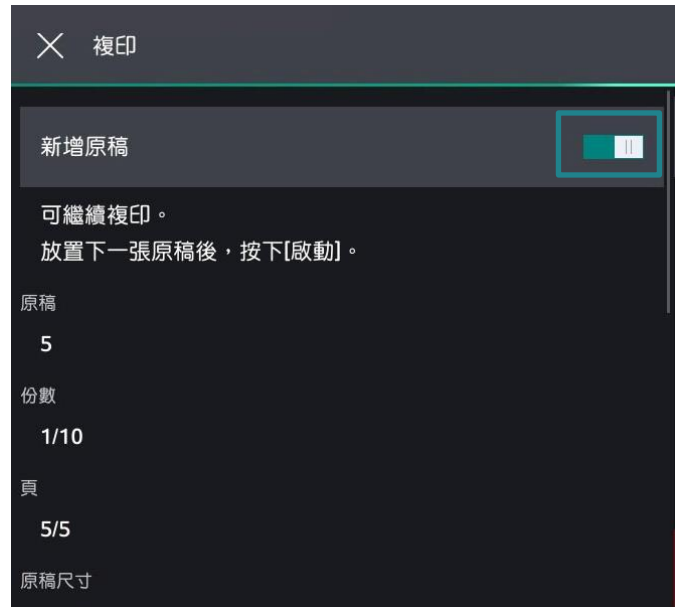

2. Load the next document, and then tap on [Start].

3. When all documents have been scanned, select [Complete Scan].

2. 放入下一份原稿，點選【啟動】。

3. 已掃描所有文件後，選擇【完成掃描(送信)】。

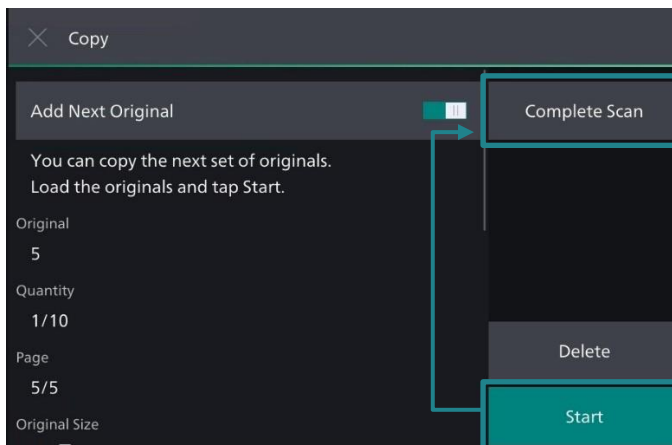

2.10.3 Interrupting the Copy Job 插印作業

You can temporarily stop the copy job to let the machine process another job first.

1. Tap on  during continuous copying.

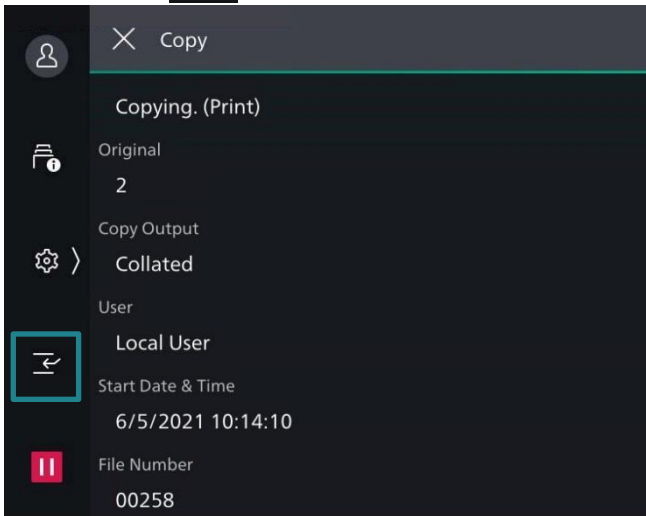

2. Set each function as needed.
3. Tap on [Start].

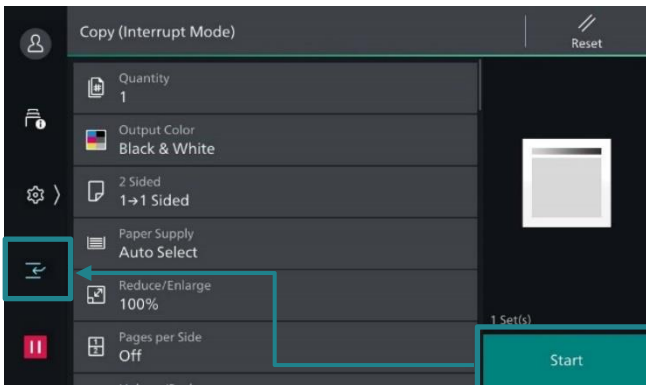

4. After an interrupt copy job is completed, tap .

您可以暫時停止複印工作，讓本機先處理另一個工作。

1. 在連續複印中，點選 。



2. 點選功能。
3. 點選【啟動】。

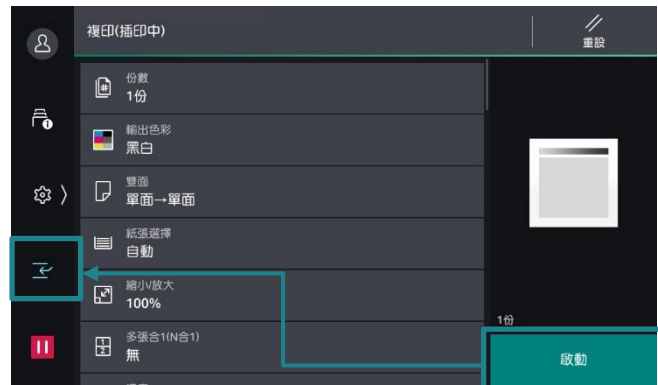

4. 插印完成後，點選 .

Customer Support Center

2513-2513