



## Quick Reference Notes - FAX

### 簡易操作 - 傳真

Apeos 7580 / 6580

# CONTENTS

## 目錄

1	Fax Procedure 傳真步驟.....	1
1.1	Loading Document 放置原稿.....	1
1.1.1	Document Feeder 自動送稿裝置.....	1
1.1.2	Document Glass 玻璃面板.....	1
1.2	Specifying Destinations 選擇指定通訊目的地.....	2
1.2.1	Using the Numeric Keypad 使用數字鍵.....	3
1.2.2	Using the Address Book 使用電話簿.....	4
1.2.3	Removing Specified Recipient 刪除指定的受信方.....	5
1.3	Confirming The Fax Job In Job Status 確認傳真工作.....	6
2	General Settings 基本傳真.....	7
2.1	Lighten/Darken 濃度.....	7
2.2	2 Sided Scanning 雙面原稿輸送.....	8
2.3	Original Type 原稿畫質.....	9
2.4	Resolution 送信畫質.....	10
2.5	Acknowledgement Report 送信確認報表.....	11
2.6	Transmission Header Text 發信方記錄.....	12
2.7	On-Hook 免持聽筒.....	13
3	Operations During Faxing 傳真期間的操作.....	14
3.1	Stopping The Fax Job 停止傳真.....	14
3.2	Previewing The Read Images During A Fax Job 傳真時預覽讀取的影像.....	16
4	Load The Next Document 放置下一份原稿.....	17

**Scan QR Code OR Click [here](#) for more instruction.**

請掃描 QR Code 或者點擊這裡查看更多使用說明。

For more online support information please visit

更多相關資料，請訪問以下網址：

<https://support-fb.fujifilm.com>



# 1 FAX PROCEDURE 傳真步驟

## 1.1 LOADING DOCUMENT 放置原稿

### 1.1.1 Document Feeder 自動送稿裝置

1. Confirm that the document is free of tag paper, adhesive tape, staples, and clips, and stretch out the document if it is wrinkled or folded.
  2. Align the upper left corner of the document so that the original size is correctly detected.
  3. Load the document face up (when the document is 2-sided, place the front side up) in the center of Document Feeder.
1. 確認原稿上沒有便利貼、膠帶、釘書針或萬字夾等物品，並將有皺褶的原稿確實整平。
  2. 對齊原稿左上角，以便正確偵測原稿尺寸。
  3. 讀取面(雙面原稿時則為正面)朝上，並放置於送稿裝置的中央。

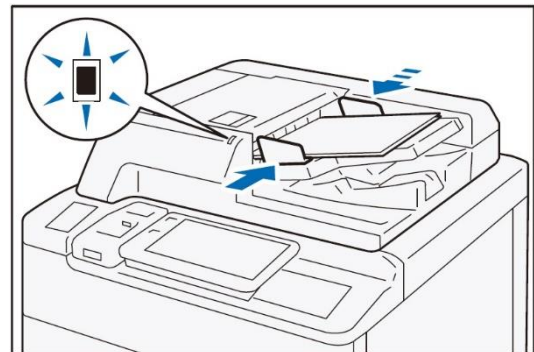
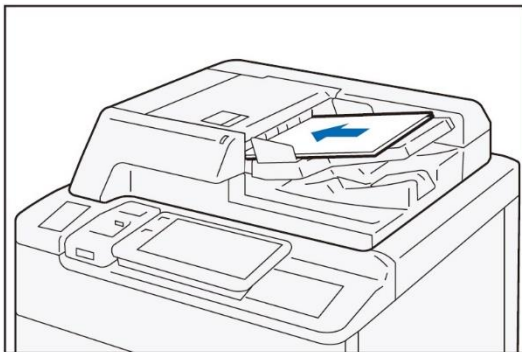

### 1.1.2 Document Glass 玻璃面板

1. Open the Document Cover.
  2. Load the document face down with the document aligned with the upper left corner of the Document Glass.
1. 打開原稿蓋。
  2. 將掃描面朝下，並對齊玻璃面板的左上角來放置原稿。

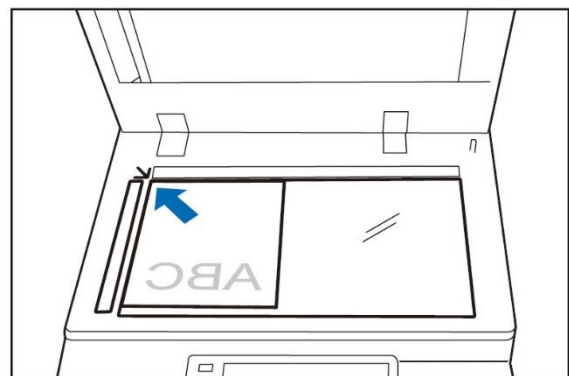
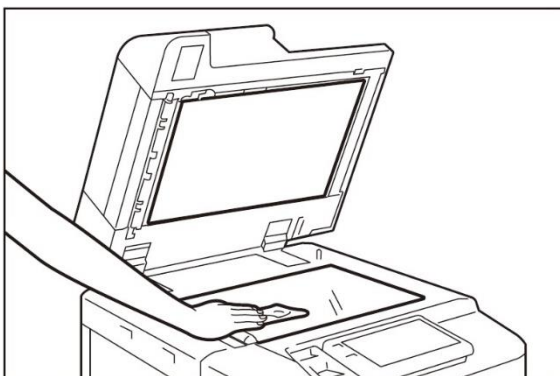

## 1.2 SPECIFYING DESTINATIONS 選擇指定通訊目的地

1. Press the Home button.

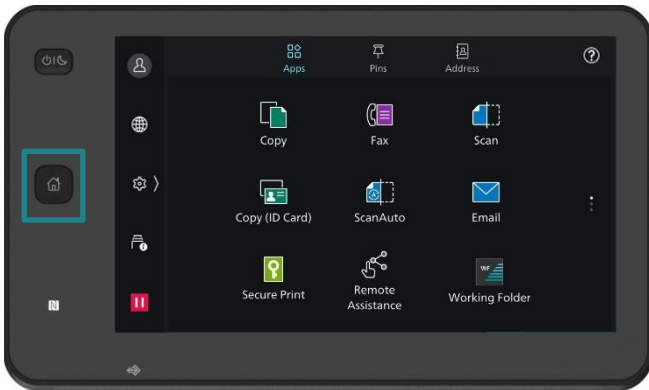

1. 按一下首頁按鈕。



2. Tap on [Fax].

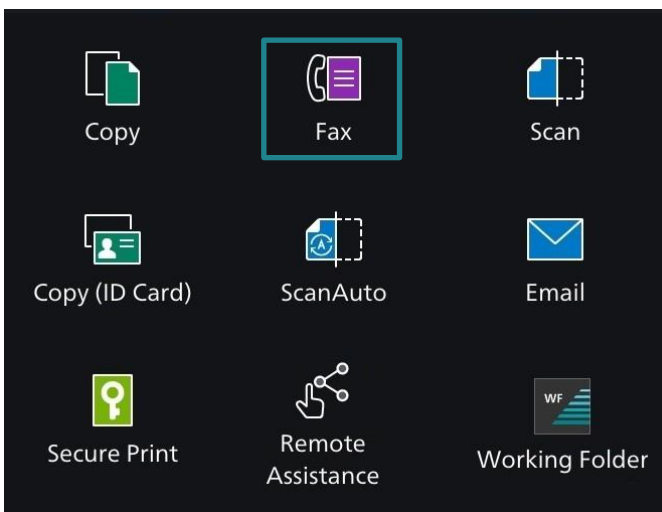

2. 點選【傳真】。



3. Configure necessary features.

4. Tap on [Start] to fax.

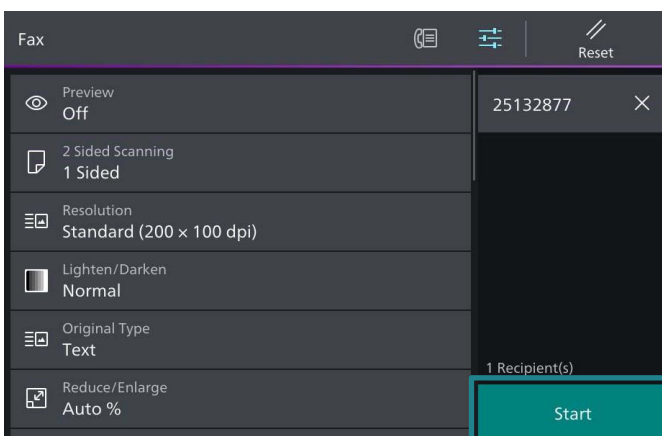

3. 設置所需功能。

4. 點選【啟動】開始傳真。

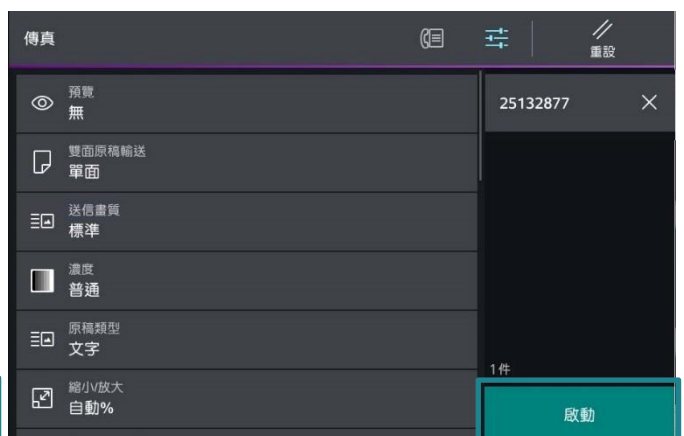

## 1.2.1 Using the Numeric Keypad 使用數字鍵

1. Tap on [Add Recipient].

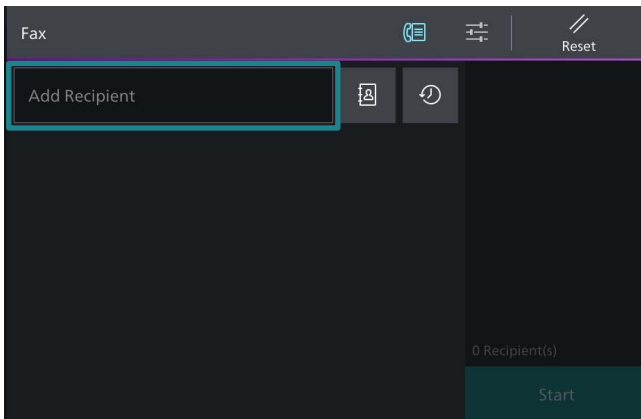

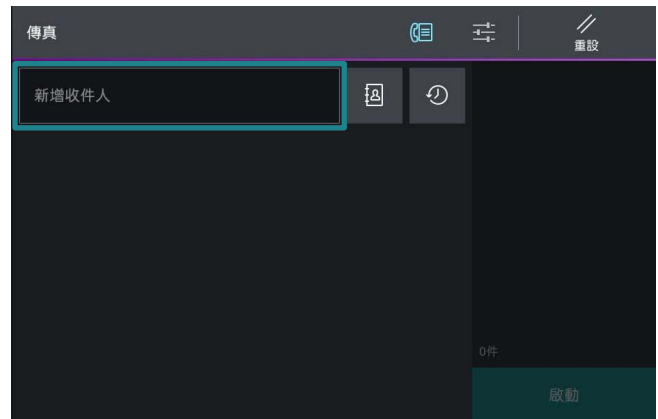

1. 點選【新增收件人】。



2. You can specify recipients using keyboard input.

2. 用數字鍵輸入傳真號碼。

3. If you enter an incorrect number, tap on  and re-enter the correct value.

3. 如果輸入數值錯誤，點選  鍵並輸入正確數值。

4. To specify multiple recipients, tap on [Add] on the touch screen after each entry.

4. 若要輸入多個傳真號碼，請在顯示幕上點選【下一對象】。

5. Tap on [Done] and tap on . Then click [Start] to start the fax job.

5. 點選【完成】及點選 ，然後按【啟動】開始傳真工作。

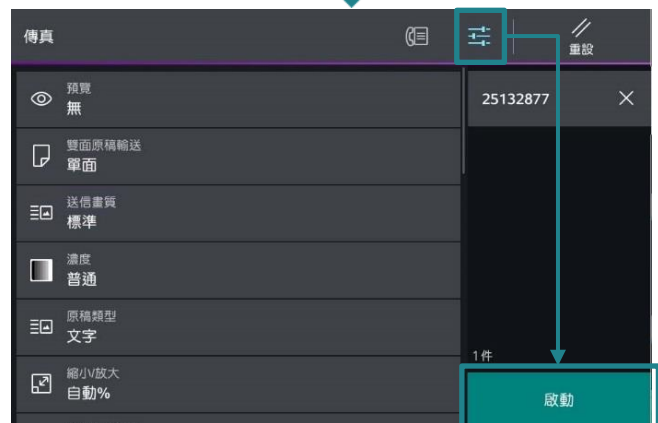
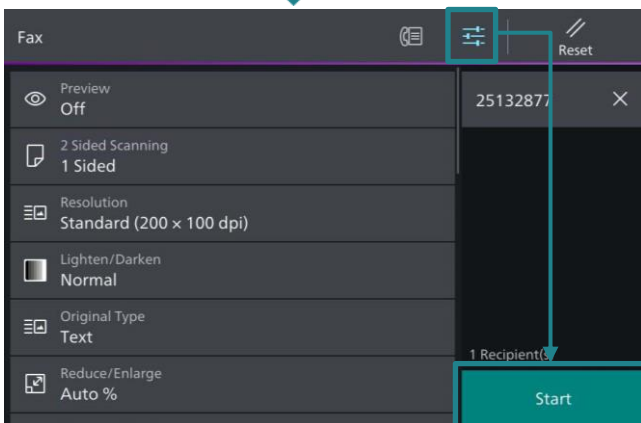
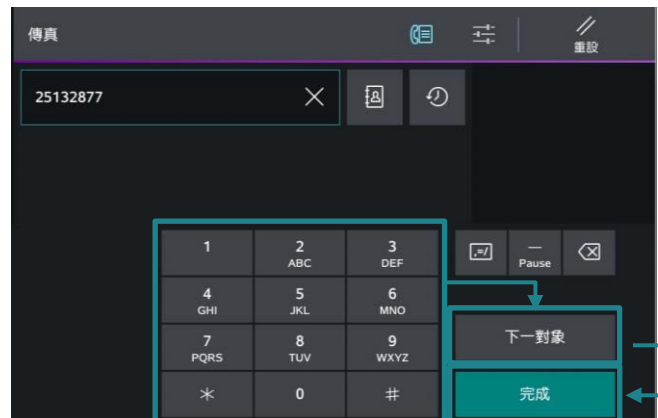
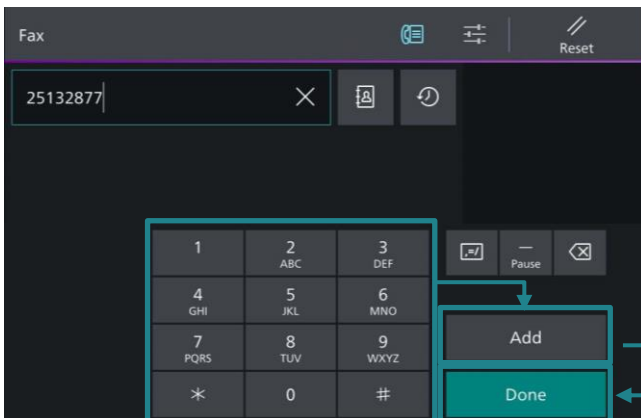

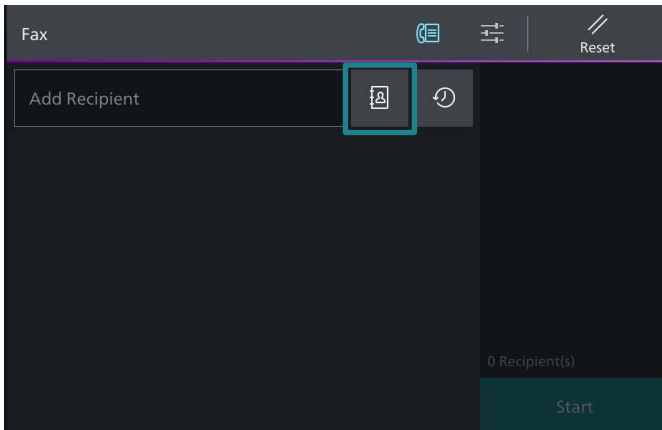

## 1.2.2 Using the Address Book 使用電話簿

1. Tap on .

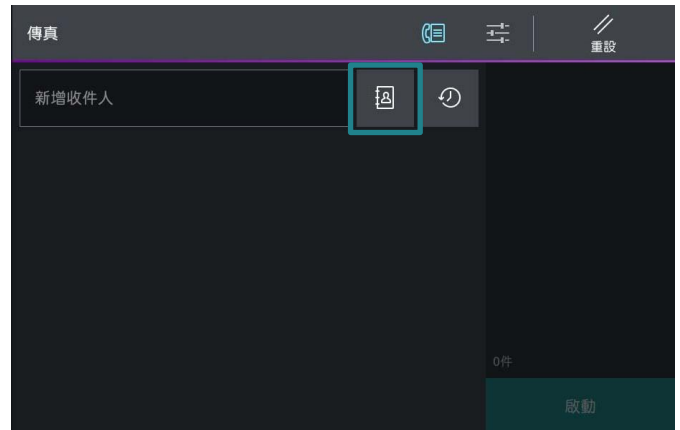

1. 點選 .



2. Select the recipient numbers from . Press [OK].

Note:

You can select multiple numbers at Step 2.

2. 按  選擇傳真號碼，然後按【OK】。

注意：

您可以在步驟 2 指定多個通信對象。

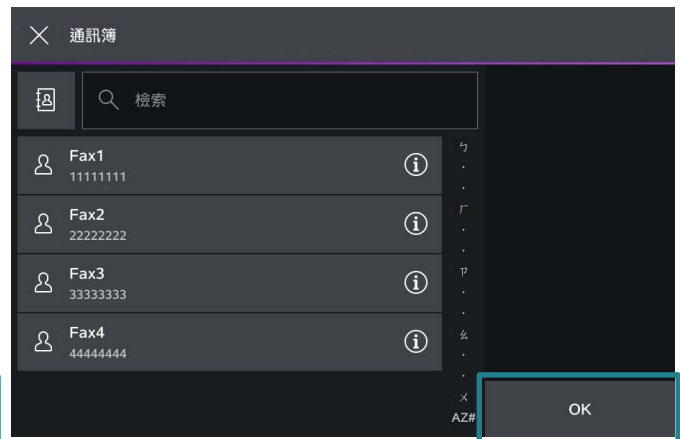
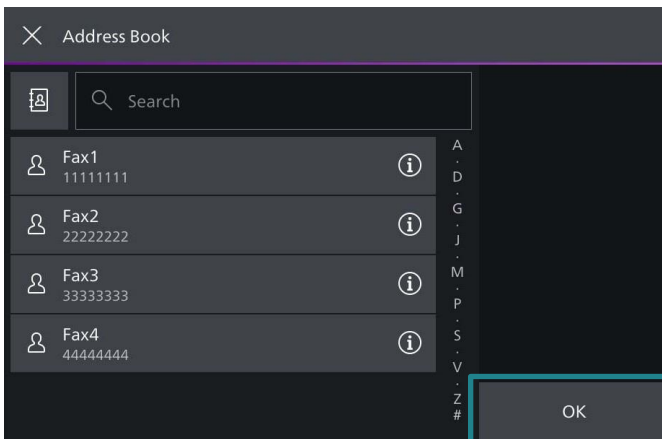

3. Tap on [Start] to start the fax job.

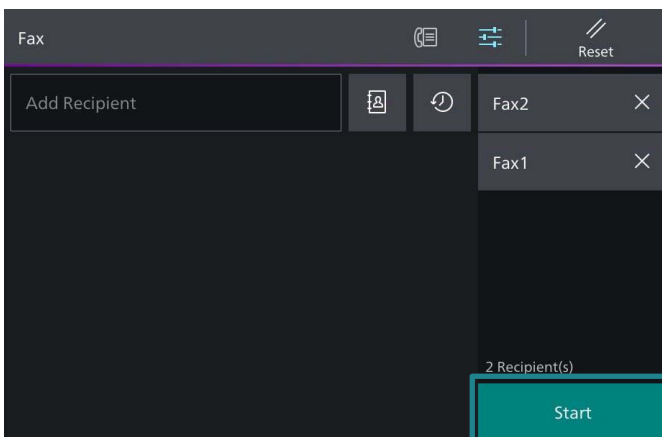

3. 點選【啟動】開始傳真工作。

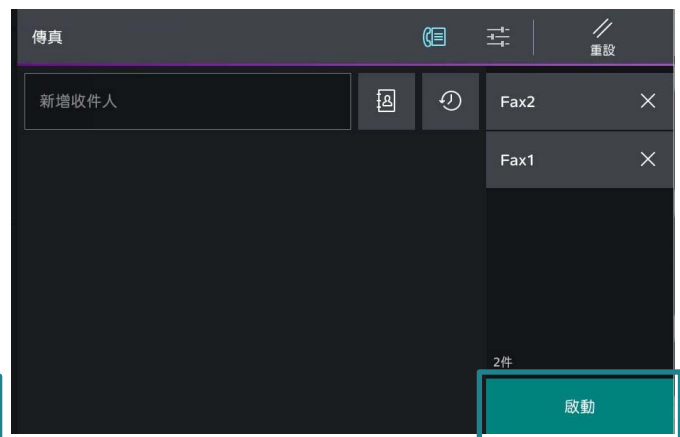

### 1.2.3 Removing Specified Recipient 刪除指定的受信方

1. Select the recipient to delete. Tap on [Delete].

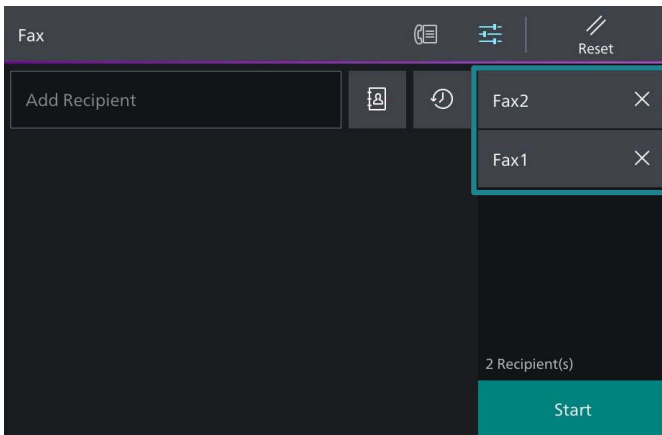

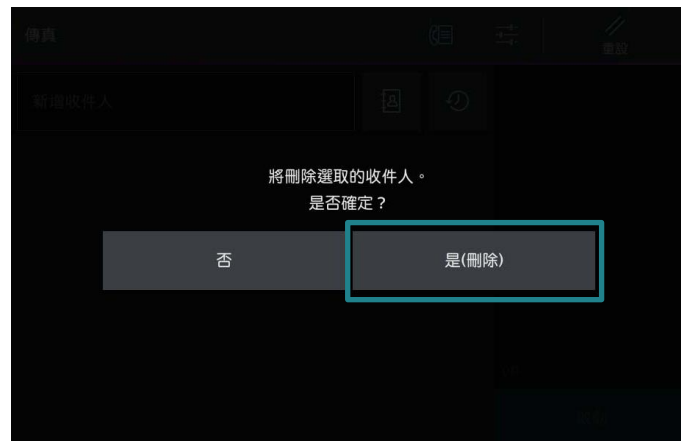
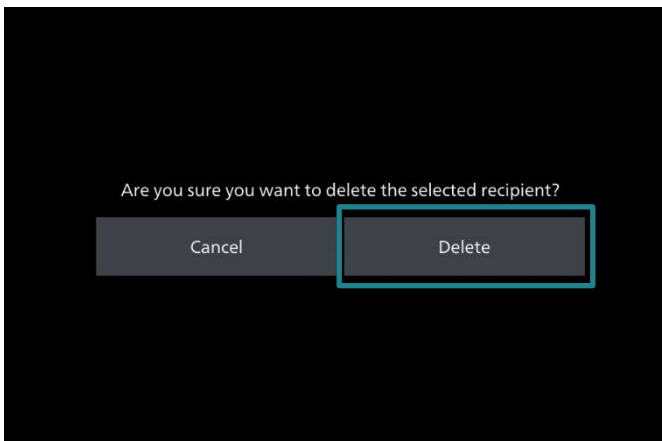
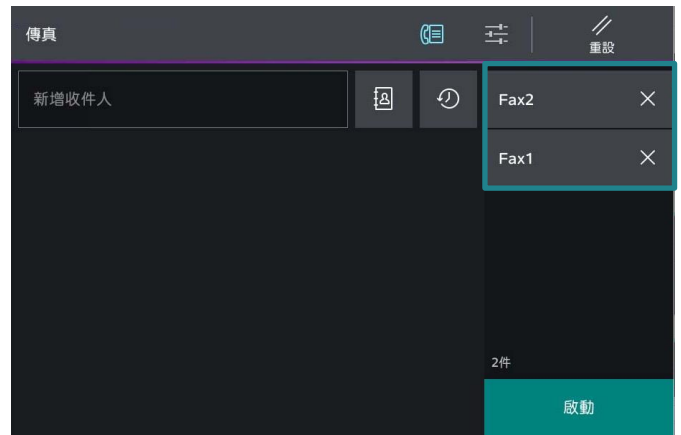

1. 選擇要刪除的傳真號碼，然後按【是 (刪除)】。

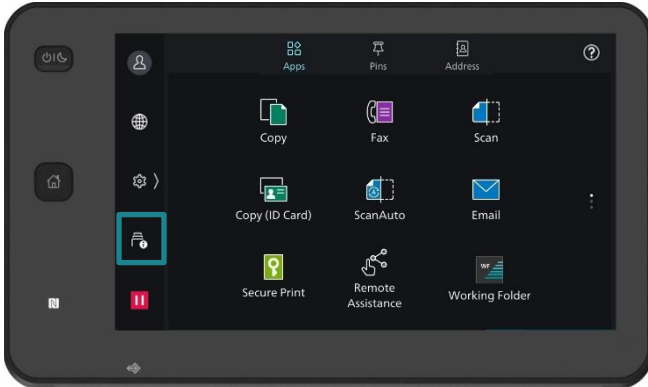

## 1.3 CONFIRMING THE FAX JOB IN JOB STATUS 確認傳真工作

1. Tap on .



1. 點選 。



2. Confirm the job status.

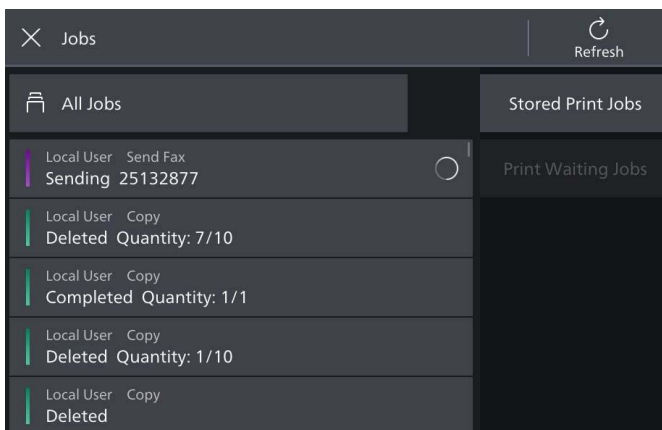

2. 確認工作狀態。





## 2 GENERAL SETTINGS 基本傳真

### 2.1 LIGHTEN/DARKEN 濃度

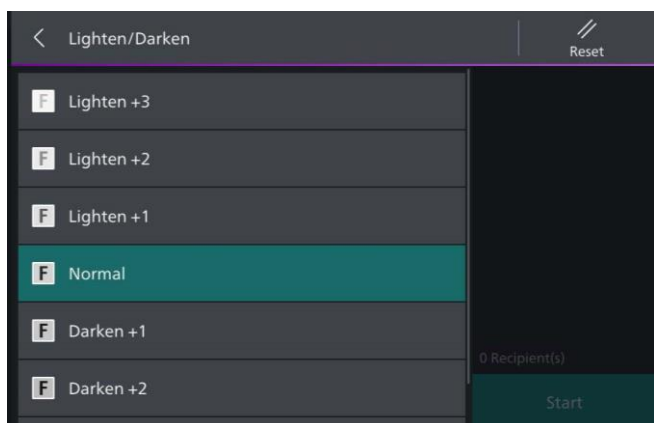
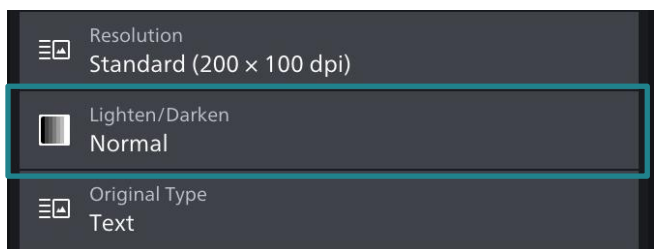

You can adjust fax density.

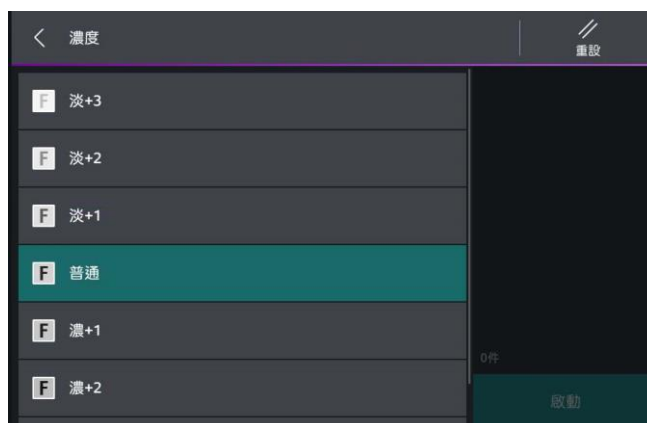
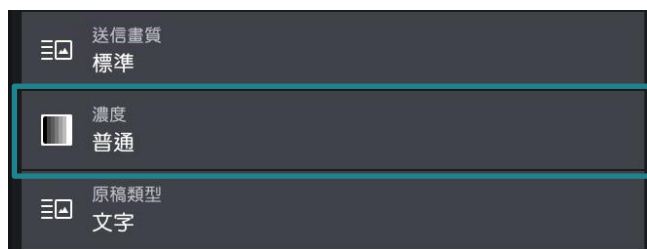

傳真濃度有七種等級選擇。

## 2.2 2 SIDED SCANNING 雙面原稿輸送

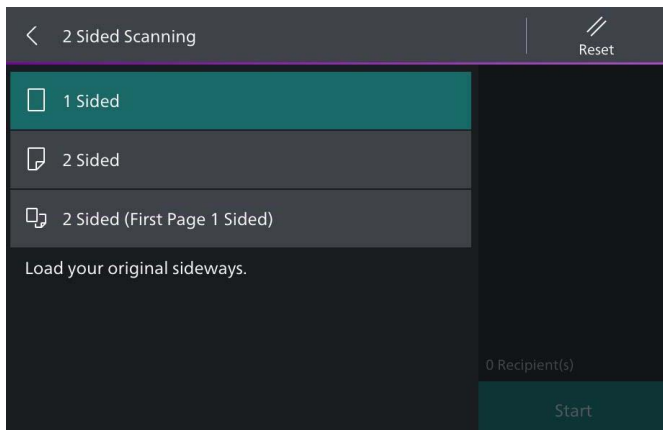
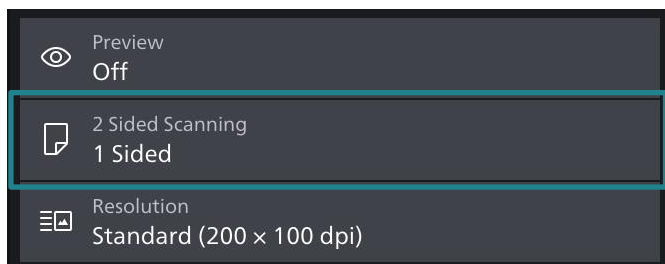

### 1 Sided

Select to transmit 1-sided documents.

### 2 Sided

Select to transmit 2-sided documents.

### 2 Sided (First Page 1 Sided)

Select this option to scan the front side of the first page and both sides of the remaining pages. Use this item when the back side of the first page is blank.

### Head to Head

Select this option when you want the orientation of the front and back sides of the scan to be the same as that of the document.

### Head to Toe

Select this option when you want the orientation of the front and back sides of the scan to be the opposite of that of the document.

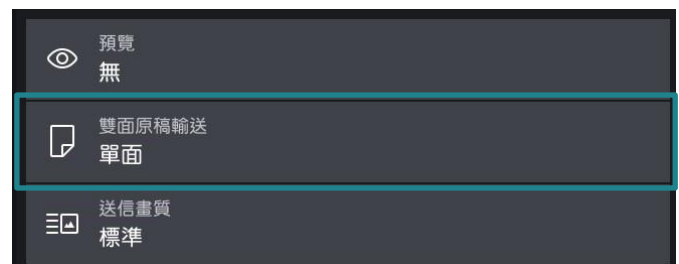

### 單面

傳送單面原稿時選擇。

### 雙面

傳送雙面原稿時選擇。

### 雙面(僅封面為單面)

要傳送第一張的正面及其餘張數的兩面時選擇。若第一張的背面空白時，請用這個選項。

### 左右對開

當您希望原稿的正面和反面的方向與文件方向相同時，請選擇此項。

### 上下對開

當您希望原稿的正面和反面的方向與文件方向相反時，請選擇此項。

## 2.3 ORIGINAL TYPE 原稿類型

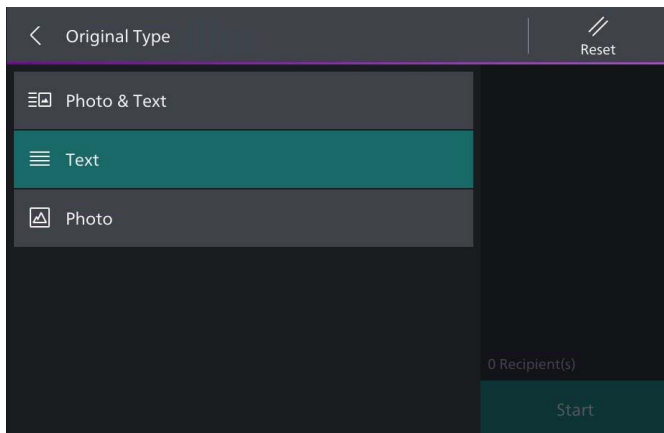
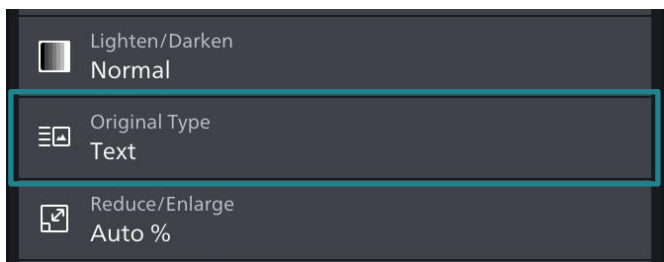

### Photo & Text

Transmitting a document that contains both text and photos.

### Text

Transmitting a document that contains only text.

### Photo

Transmitting a document that contains only photos.

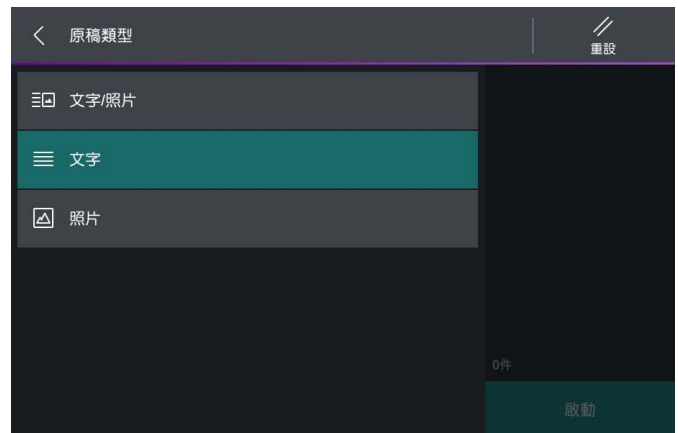
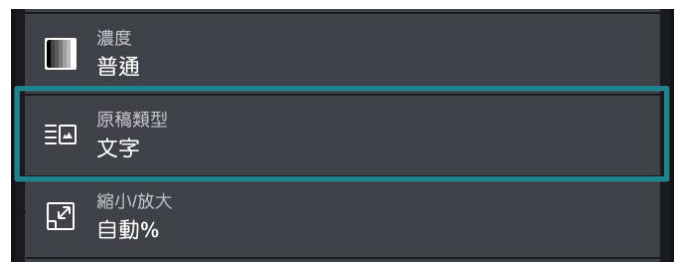

### 文字 / 照片

傳送帶有文字及照片的原稿時選擇。

### 文字

傳送僅帶有文字的原稿時選擇。

### 照片

傳送僅帶有照片的原稿時選擇。

## 2.4 RESOLUTION 送信畫質

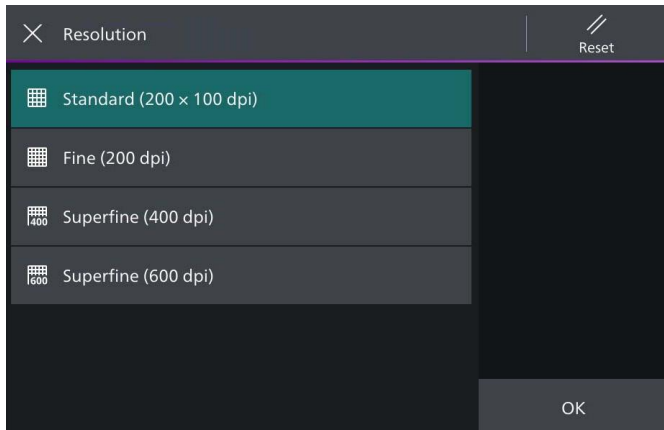
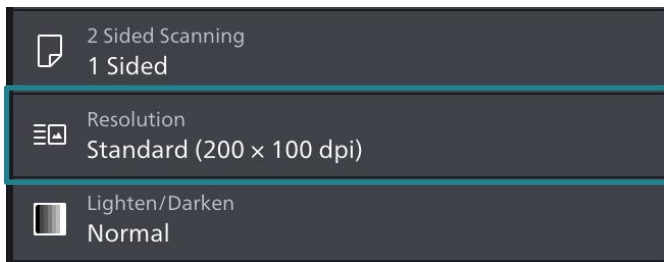

### Standard (200 x 100 dpi)

Transmitting standard documents

### Fine (200dpi)

Transmitting documents with small text or detailed images.

### Superfine (400dpi)

Transmitting documents with fine images

### Superfine (600dpi)

Transmitting documents with extremely fine images

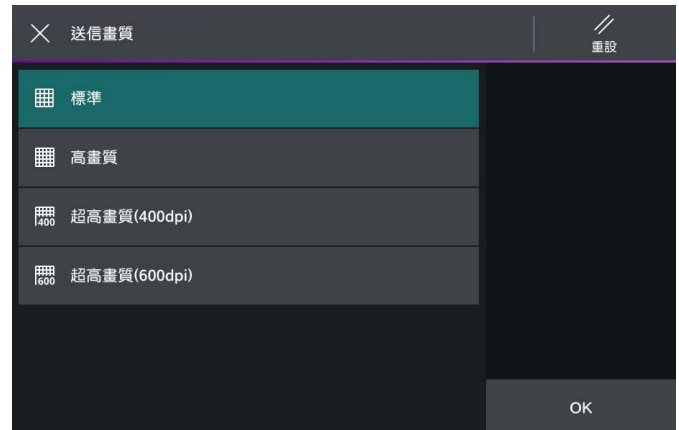
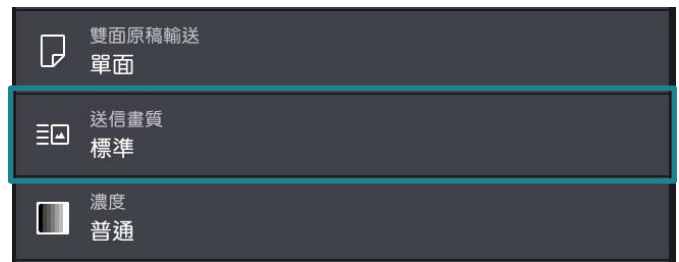

### 標準

傳送文字清晰的普通原稿時選擇。

### 高畫質

傳送小字及/或細緻影像原稿時選擇。

### 超高畫質(400 dpi)

傳送極小字體及/或極細緻影像原稿時選擇。

### 超高畫質(600 dpi)

傳送極小字體及/或極細緻影像原稿時選擇。

## 2.5 TRANSMISSION REPORT 送信確認報表

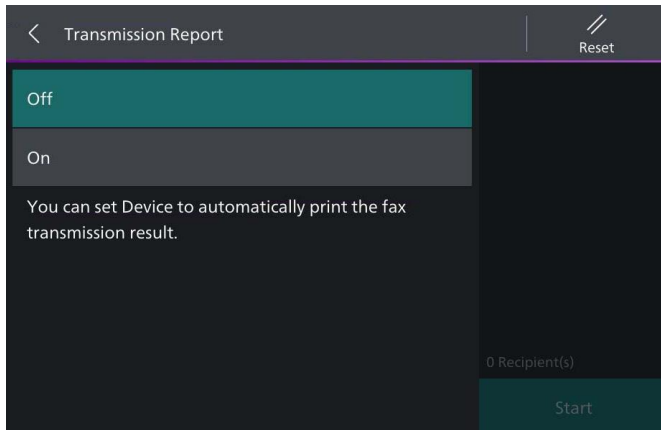
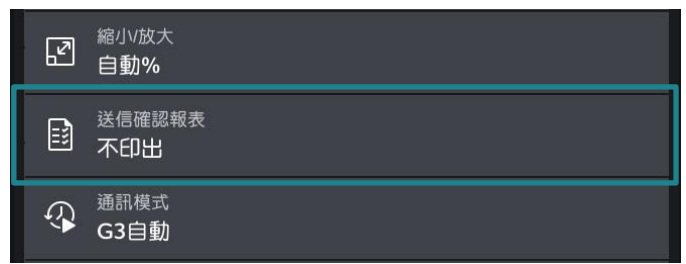

**Off**

No Transmission Report is printed.

**On**

Transmission Report is automatically printed.

**不印出**

不列印送信確認報表。

**印出**

傳送完成時，自動列印送信確認報表。

## 2.6 TRANSMISSION HEADER 發信方記錄

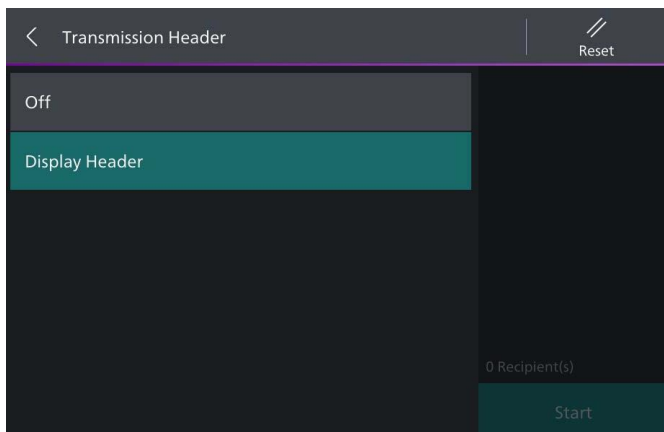
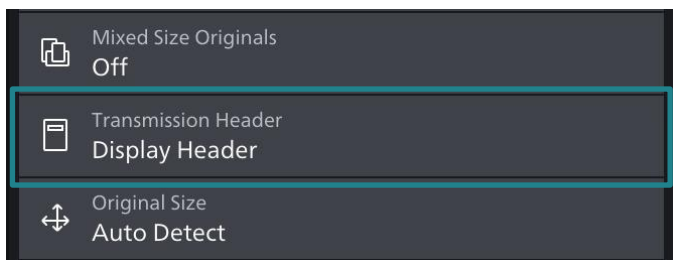

**Off**

No header information is attached.

**Display Header**

Header information is attached.

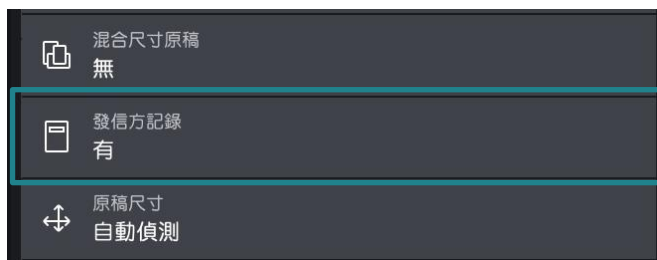

**無**

不附加發信方資訊。

**有**

附加發信方資訊。

## 2.7 ON-HOOK (MANUAL SEND / RECEIVE) 免持聽筒 (手動送信 / 受信)

Use this feature when using Manual Send.

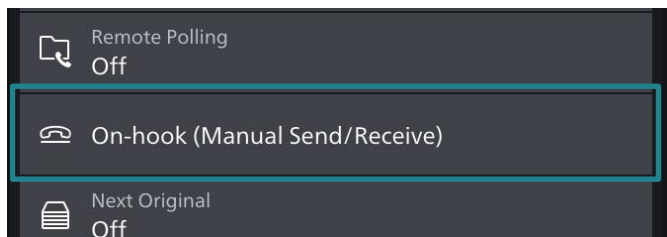

使用手動送信時，請使用此功能。

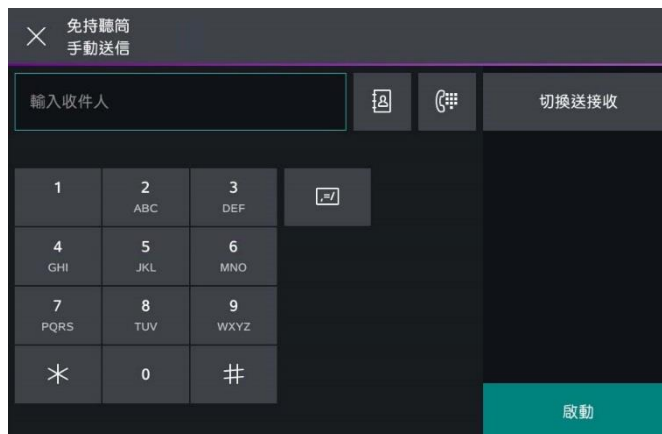
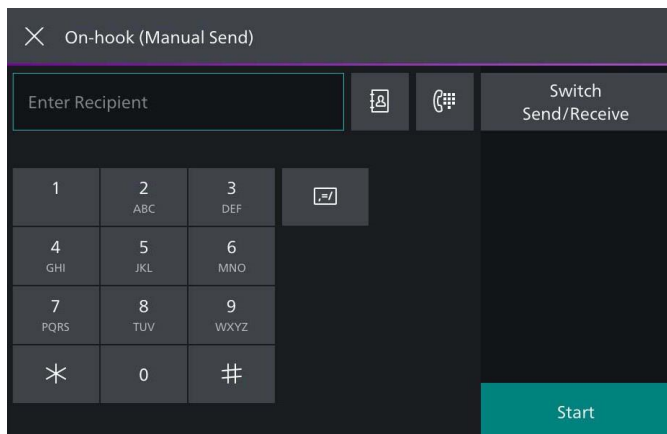
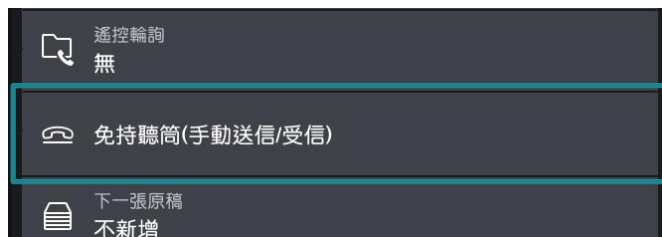

### Entering Recipient

Use alphanumeric characters to specify a destination. Then, press [Start] to start the fax job.



Cut the connected line.

### 輸入收件人

使用英數字元指定收件人。按【啟動】開始傳真工作。



切斷連線。

## 3 OPERATIONS DURING FAXING 傳真期間的操作

### 3.1 STOPPING THE FAX JOB 停止傳真

1. Tap on [Pause] on the touch screen.

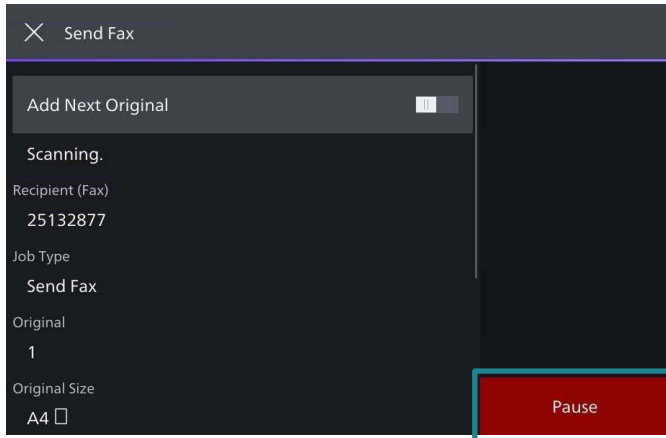

1. 點選操作面板上的【停止】。

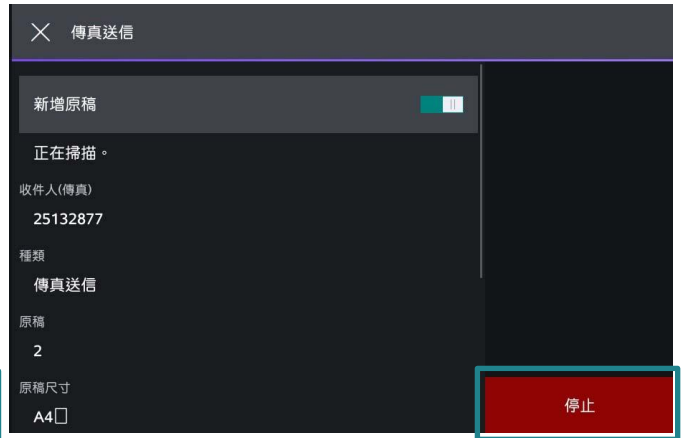

2. Tap on [Delete].



2. 點選【中止】。

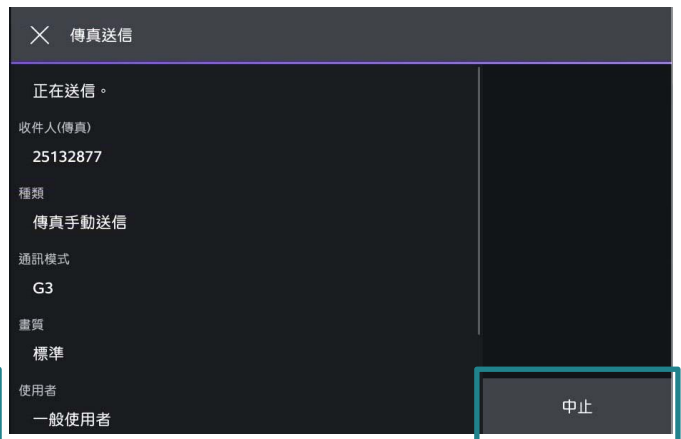

3. If the screen in step 1 or 2 does not appear, tap on  .

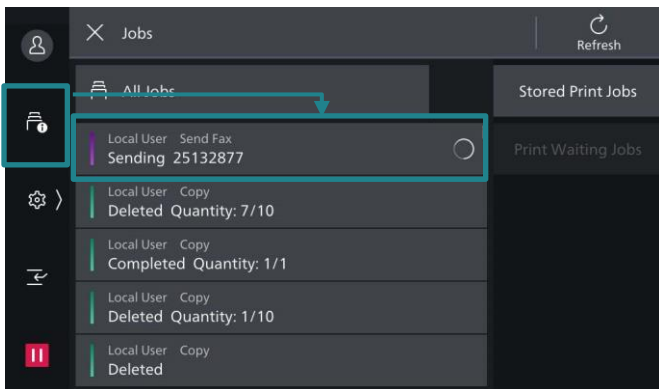

3. 若未顯示步驟 1 或 2 中的畫面，點選  。





#### 4. Tap on [Delete].

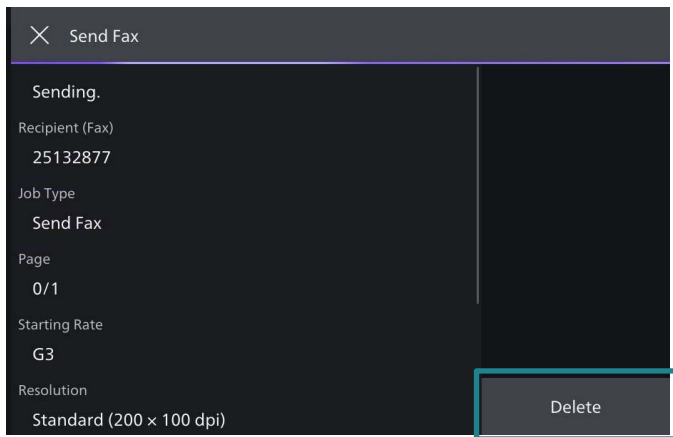

#### 4. 點選【中止】。

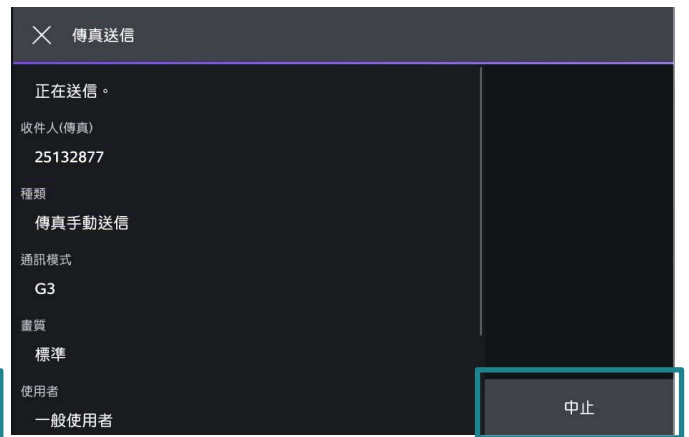

## 3.2 PREVIEWING THE READ IMAGES DURING A FAX JOB 傳真時預覽讀取的影像

You can preview the read images while reading the next document.

1. Tap on [Preview].

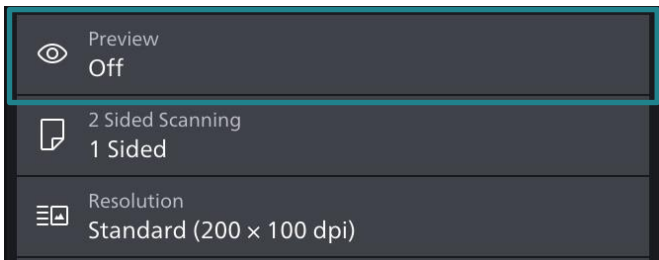

讀取下一個文件時，您可預覽之前讀取的影像。

1. 點選【預覽】。

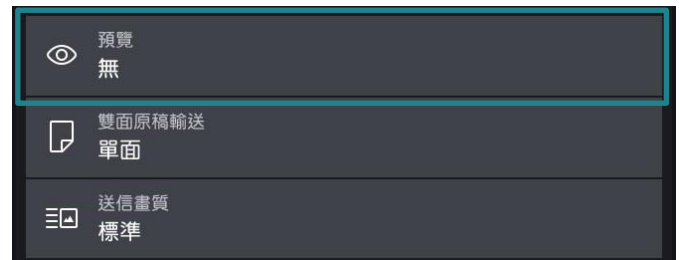

2. Tap on [On]. Then press [Start].

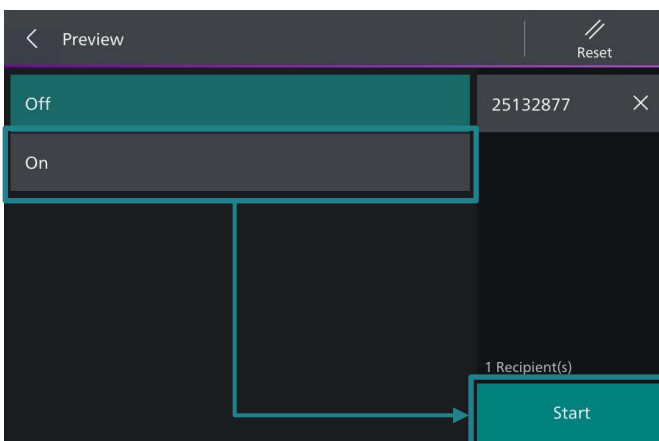

2. 點選【有】，然後選擇【啟動】。

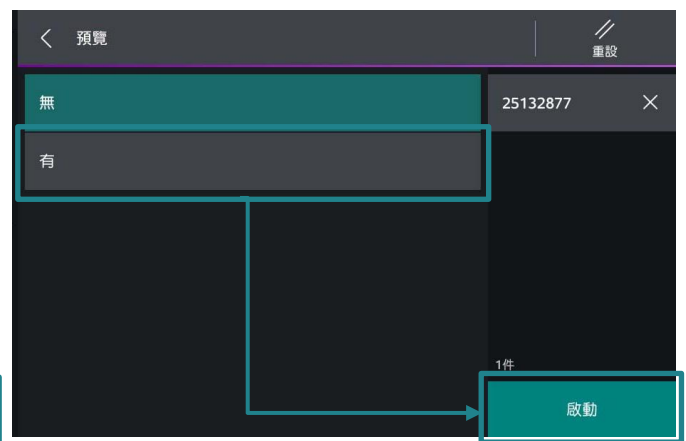

3. An entire preview image is displayed.  
When all documents have been scanned,  
tap on [Send (All)].

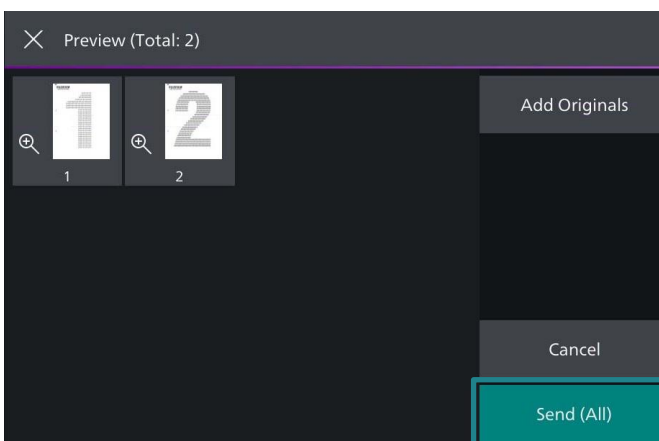

3. 整體顯示預覽影像。  
完成掃描所有文件後，點選  
【送信(全部)】。

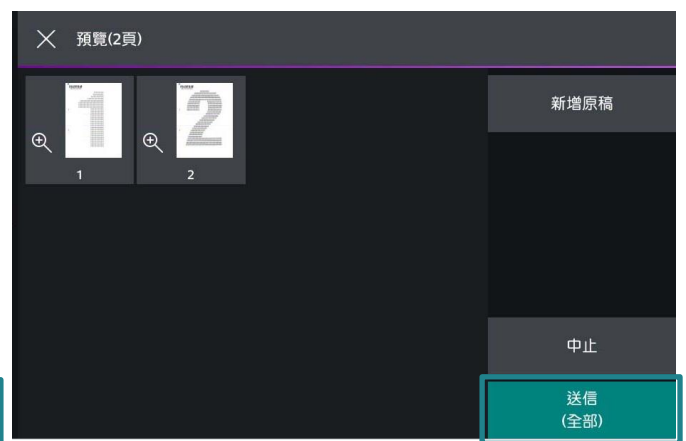

## 4 LOAD THE NEXT DOCUMENT 放置下一份原稿

If you have another document, tap on  on the touch screen while the current document is being scanned.

1. Tap on  while scanning is in progress.

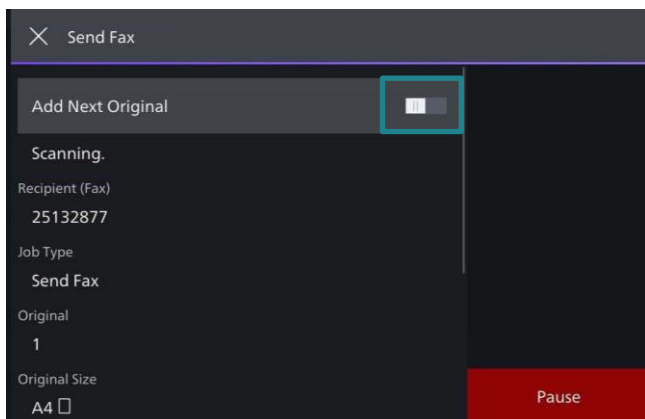

2. Load the next document.
3. Tap on [Scan].

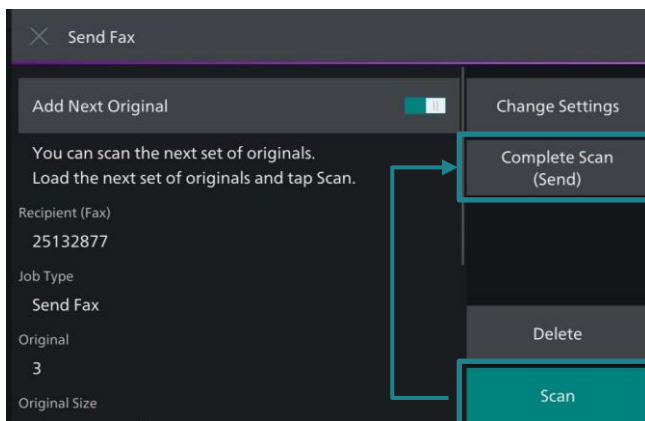

4. When all documents have been scanned, select [Complete Scan (Send)].

如果還有其他原稿，請在掃描原稿時，在顯示幕上點選 。

1. 請在掃描進行期間點選 。

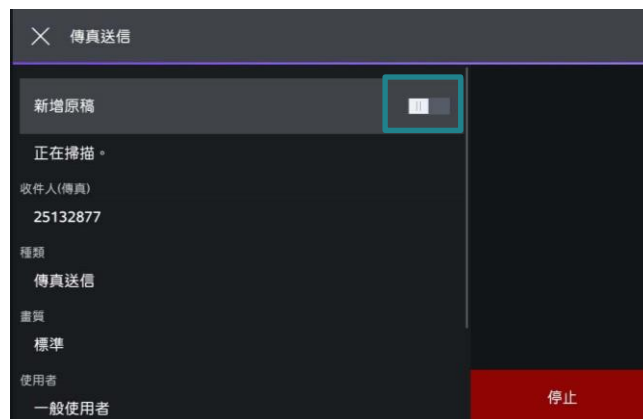

2. 放入下一份原稿。
3. 點選【掃描】。



4. 所有原稿掃描之後，請選擇【完成掃描 (送信)】。

# Customer Support Center

## 2513-2513

FUJIFILM and FUJIFILM logo are registered trademarks or trademarks of FUJIFILM Corporation.

Apeos, ApeosPro, ApeosWiz, Working Folder is registered trademarks or trademarks of FUJIFILM Business Innovation Corp.

Adobe, Adobe logo, PostScript and PostScript logo are either registered trademarks or trademarks of Adobe in the United States and/or other countries.

Apple, AirPrint and Mac are trademarks of Apple Inc. registered in the U.S. and other countries.