



**Apeos 5330 / 4830**



**No. and Component**

- 1) <Power Saving> button
- 2) Jobs
- 3) <Home> button
- 4) Data indicator
- 5) Login / Out
- 6) Pins
- 7) Address Book

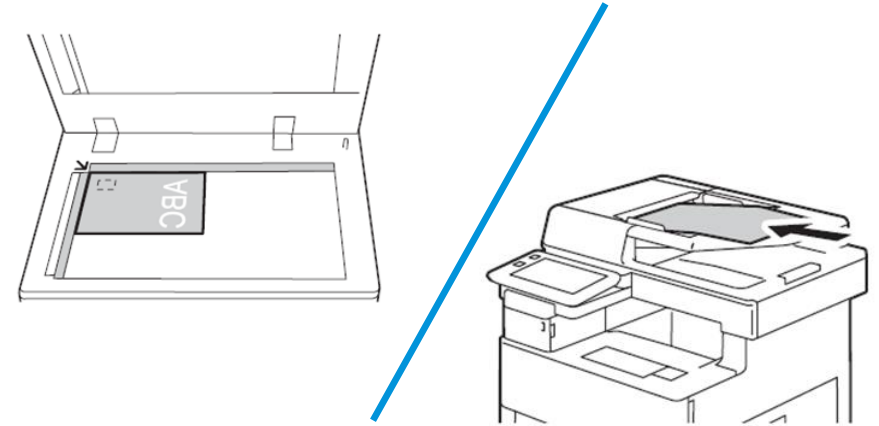

For assistance, please call 2513 2513.

**Copy**

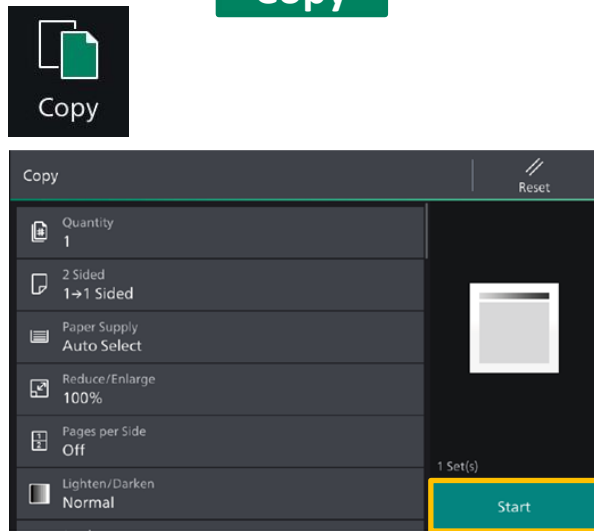

Configure the print quantity and the setting items. Tap on [Start].

**Stop Copy**

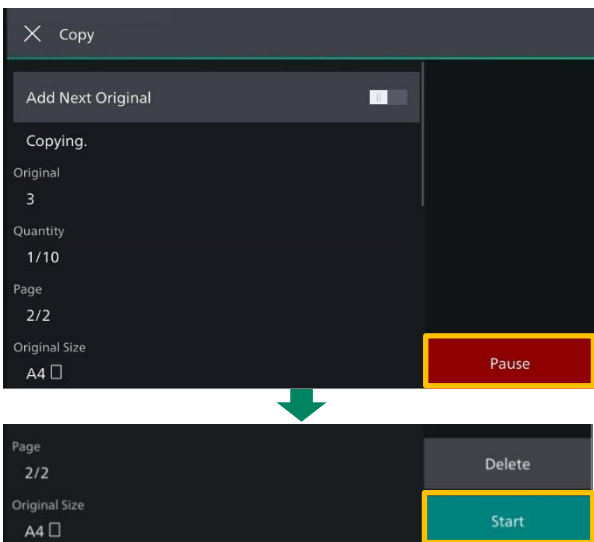

Tap on [Pause], then tap on [Delete].

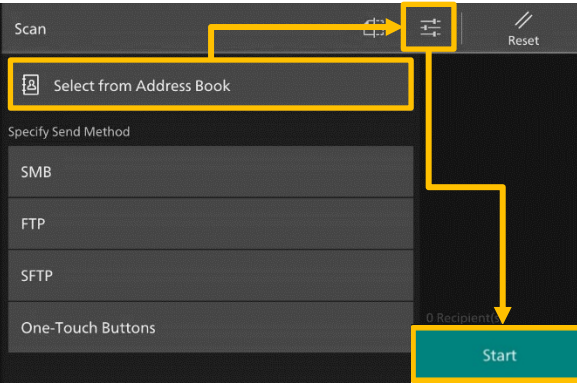

Specify the recipient by tapping on the [Address Book]. Configure the [Setting Items] and tap on [Start].

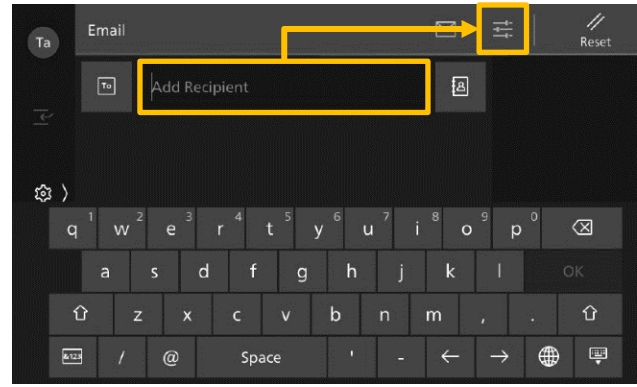
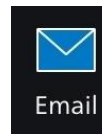

Specify recipient by using [Keyboard] or by tapping on the Address Book. Configure the [Setting Items] and tap on [Start].

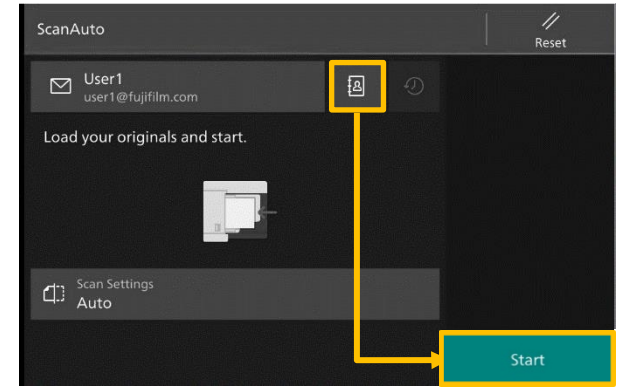

Specify recipient from [Address Book], then tap on [Start].

Scan Auto skip the blank pages and rotate the pages into correct orientation automatically.

**Fax**

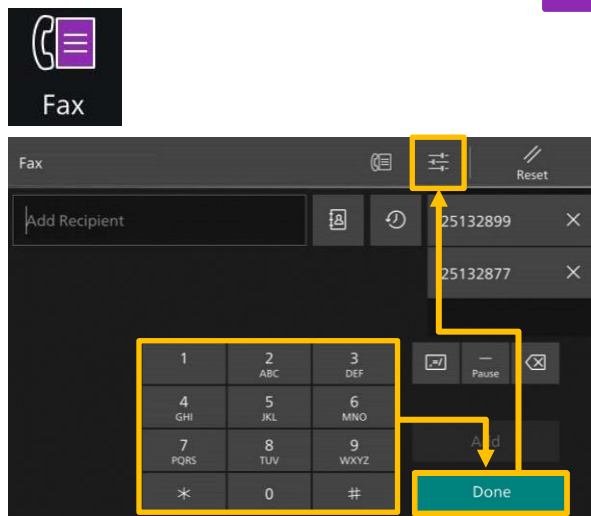

Enter the recipient with the [Keyboard] and tap on [Done]. Configure the [Setting Items] and tap on [Start].

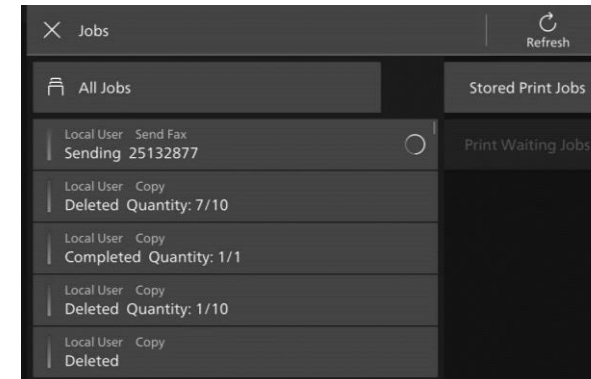

After fax transmission, tap on [Jobs] to verify the job completion status.

You can check active jobs (both running and waiting) and completed jobs.

**Enquiry**

Scan QR Code for more instruction.



Visit below website for more online support.  
<https://support-fb.fujifilm.com>