



## Quick Reference Notes - SCAN

### 簡易操作 - 掃描

Apeos C8180 / C7580 / C6580

# CONTENTS

## 目錄

1	Scanning Procedure 掃描步驟 .....	1
1.1	Loading Document 放置原稿.....	1
1.1.1	Document Feeder 自動送稿裝置.....	1
1.1.2	Document Glass 玻璃面板.....	1
1.2	Selecting Scan Location 選擇掃描貯存位置.....	2
2	Scanning Features 掃描選項.....	4
2.1	Scanning Color 色彩模式 .....	4
2.2	2-Sided Scanning 雙面原稿輸送 .....	5
2.3	Original Type 原稿類型 .....	6
2.4	File Format 印出檔案格式 .....	7
2.5	Single File for Each Page 每頁皆進行分割 .....	8
2.6	Resolution 掃描解析度 .....	9
2.7	File Name 檔案名稱 .....	10
3	Operations During Scanning 掃描期間的操作.....	11
3.1	Stop The Scan Job 停止掃描.....	11
4	Load The Next Document 放置下一份原稿.....	12
5	Special Features 特別功能.....	13
5.1	Previewing And Rotating The Scanned Images 預覽掃描及旋轉影像 .....	13
5.2	Changing The Scan Settings During A Scan Job 掃描時改變掃描設定 .....	15
6	Scan Auto 自動掃描.....	17

Scan QR Code OR Click [here](https://support-fb.fujifilm.com) for more instruction.

請掃描 QR Code 或者點擊這裡查看更多使用說明。

For more online support information please visit

更多相關資料，請訪問以下網址：

<https://support-fb.fujifilm.com>



# 1 SCANNING PROCEDURE 掃描步驟

## 1.1 LOADING DOCUMENT 放置原稿

### 1.1.1 Document Feeder 自動送稿裝置

1. Confirm that the document is free of tag paper, adhesive tape, staples, and clips, and stretch out the document if it is wrinkled or folded.  
1. 確認原稿上沒有便利貼、膠帶、釘書針或萬字夾等物品，並將有皺褶的原稿確實整平。
2. Align the upper left corner of the document so that the original size is correctly detected.  
2. 對齊原稿左上角，以便正確偵測原稿尺寸。
3. Load the document face up (when the document is 2-sided, place the front side up) in the center of Document Feeder.  
3. 讀取面(雙面原稿時則為正面)朝上，並放置於送稿裝置的中央。

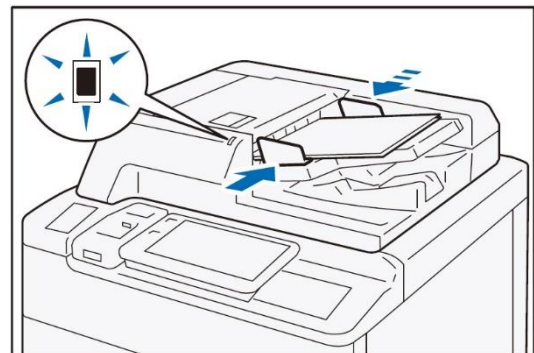
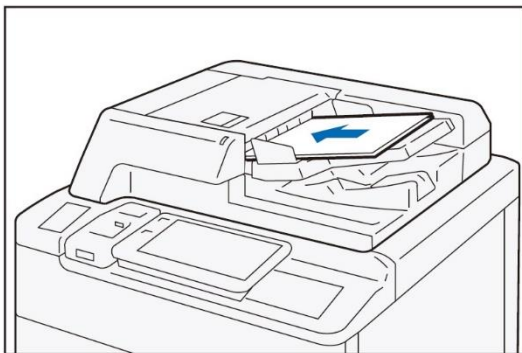

### 1.1.2 Document Glass 玻璃面板

1. Open the Document Cover.  
1. 打開原稿蓋。
2. Load the document face down with the document aligned with the upper left corner of the Document Glass.  
2. 將掃描面朝下，並對齊玻璃面板的左上角來放置原稿。

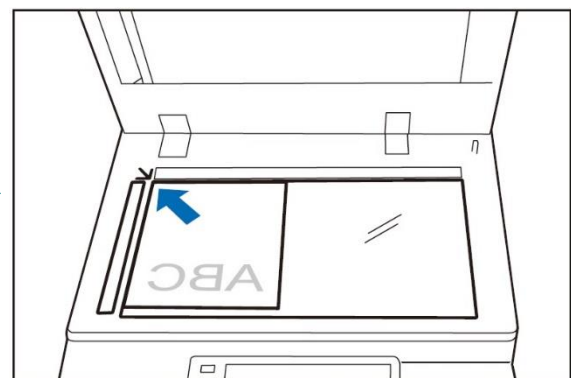
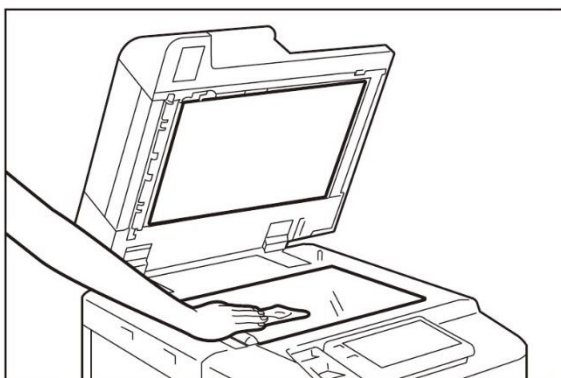

## 1.2 SELECTING SCAN LOCATION 選擇掃描貯存位置

1. Press the Home button.

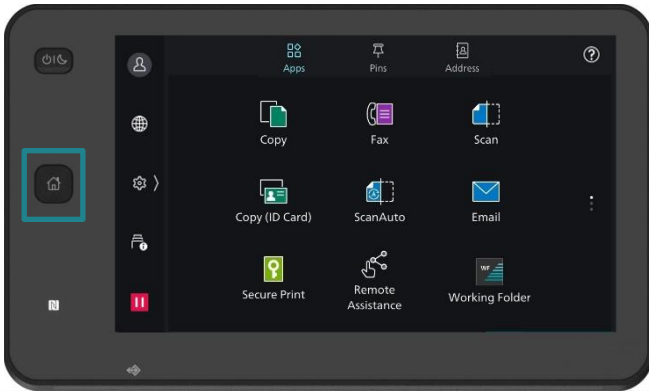

1. 按一下首頁按鈕。



2. Tap on [Scan].

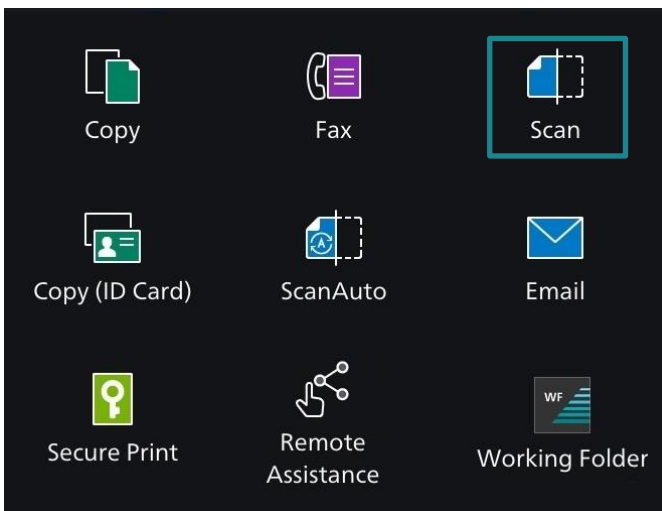

2. 點選【掃描】。



3. Tap on [Select from Address Book].

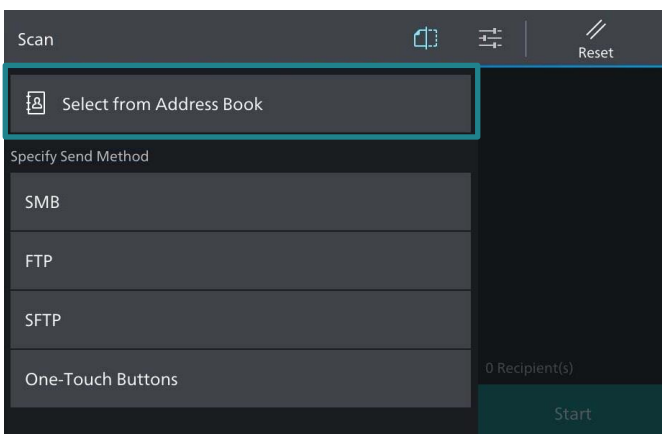

3. 點選【從通訊簿選擇】。

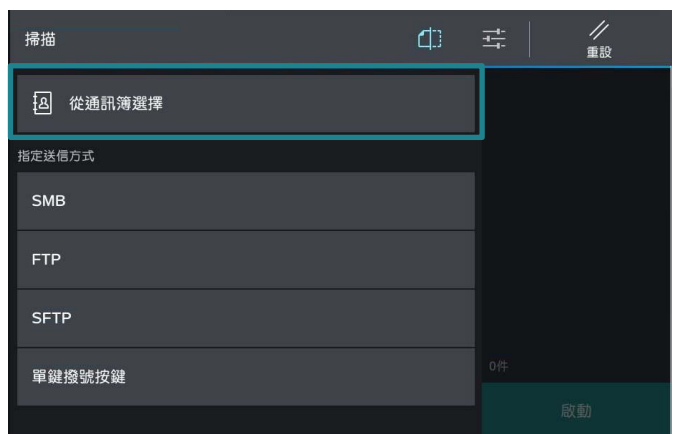

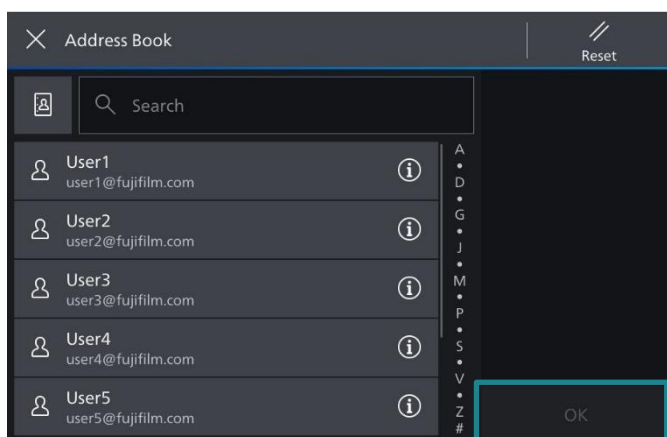

4. Select user's scan location and press [OK].

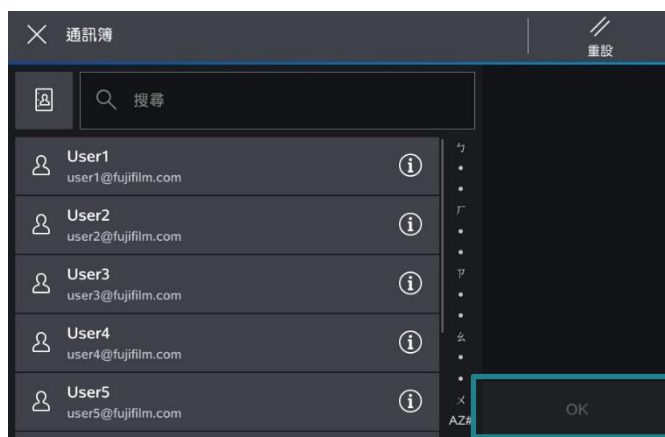

4. 選擇用戶的掃描位置，然後按【OK】。



5. Tap on  to configure necessary features.

5. 點選  以設置所需功能。

6. Tap on [Start] to scan.

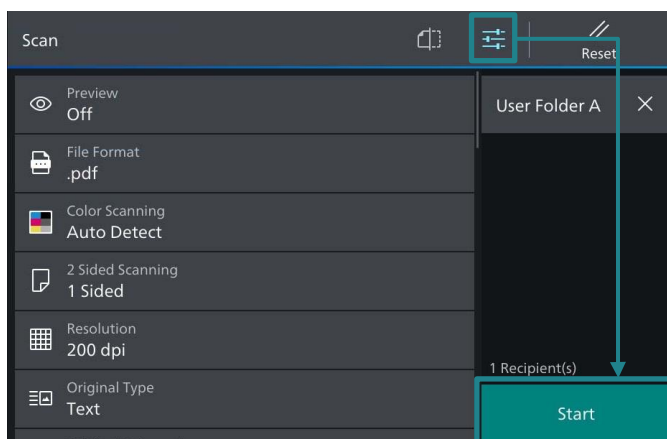

6. 點選【啟動】開始掃描。

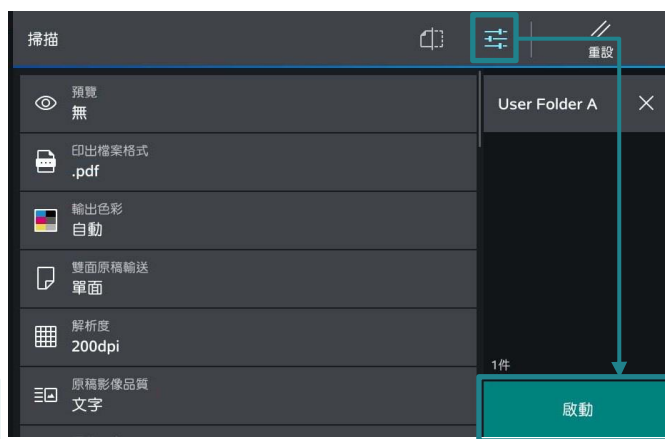

## 2 SCANNING FEATURES 掃描選項

### 2.1 SCANNING COLOR 輸出色彩

Set the scanning color for the documents to be scanned.

設定掃描原稿的色彩模式。

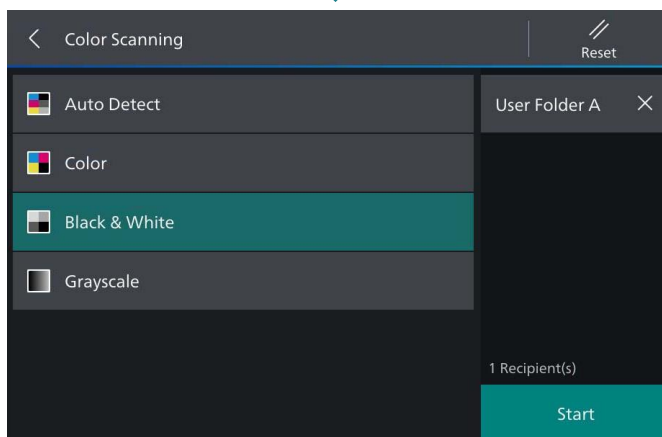
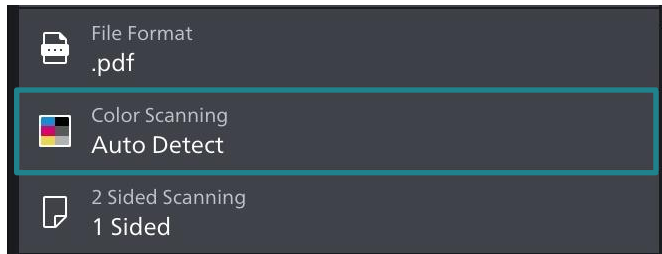

#### Auto Detect

The color of the document is determined automatically.

#### Color

Select to scan a color document.

#### Black & White

Scans a document in monochrome 2 tones.

#### Grayscale

Scans a document in grayscale. It is suited to documents containing gradations that cannot be reproduced with monochrome.

#### 自動

本機自動判定原稿的色彩。

#### 全彩

選擇掃描彩色原稿。

#### 黑白 (2 色階)

以黑白雙色掃描原稿。

#### 灰階 (256 色階)

以灰階掃描原稿。適合用於含有漸層且無法以黑白 (雙色) 方式重現的原稿。

## 2.2 2-SIDED SCANNING 雙面原稿輸送

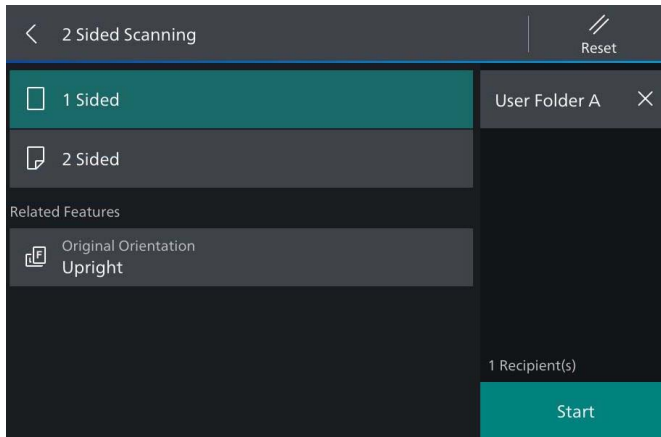
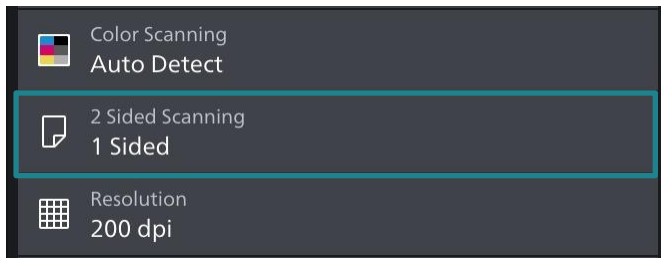

### 1 Sided

Select this to scan only 1 side of the document.

### 2 Sided

Select this to scan 2 side of the document.

### Head to Head

Select this when both sides of the 2-sided document are in the same orientation.

### Head to Toe

Select this when both sides of the 2-sided document are in the opposite orientation.

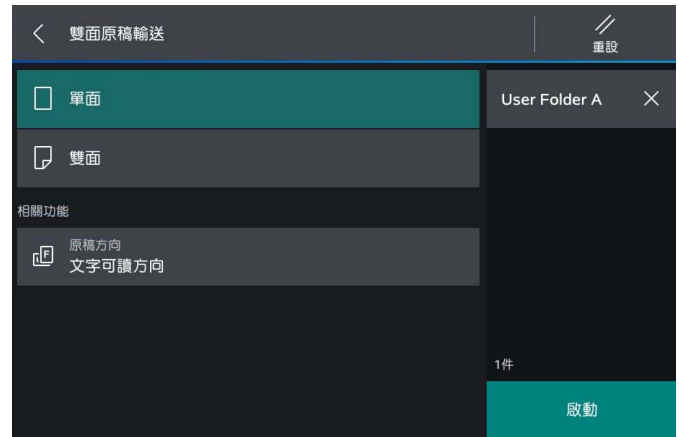
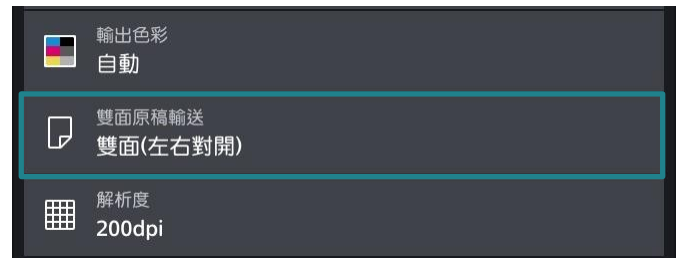

### 單面

只掃描原稿單面時，選擇此項目。

### 雙面

掃描原稿雙面時，選擇此項目。

### 左右對開

雙面原稿的兩面都在同一方向時，選擇此項目。

### 上下對開

雙面原稿的兩面相反方向時，選擇此項目。

## 2.3 ORIGINAL TYPE 原稿影像品質

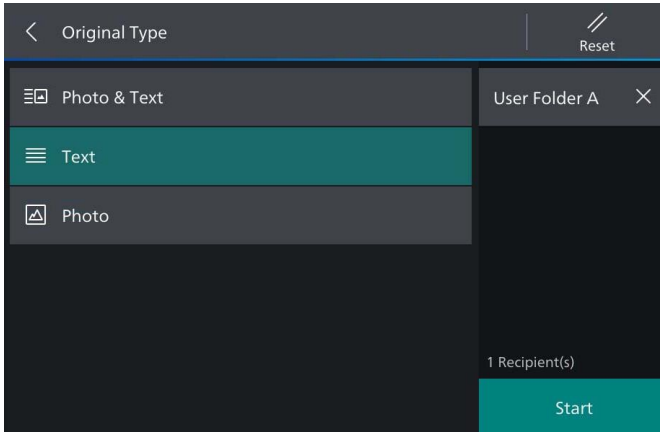
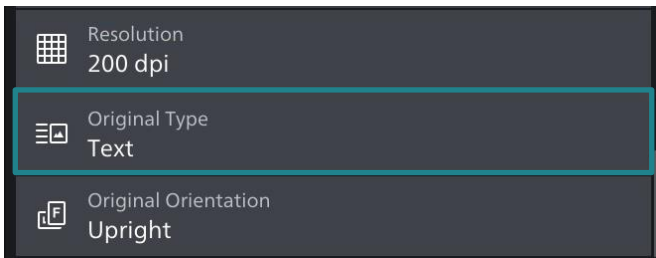

### Photo & Text

Select this item when the scanning document contains both text and photos.

### Text

Select this item when scanning text clearly.

### Photo

Select this item when scanning photos.

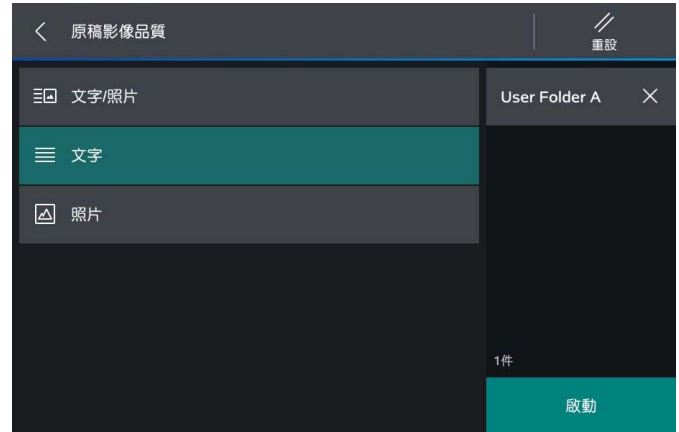
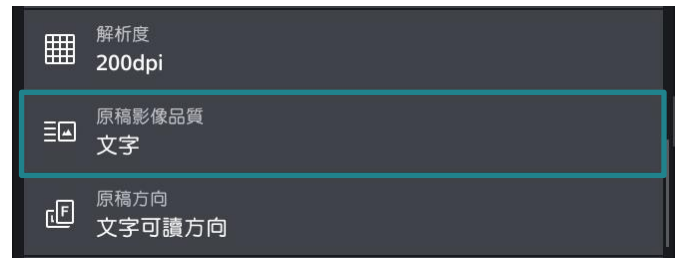

### 文字/照片

掃描包含文字及照片的原稿時選擇此項目。

### 文字

若要清晰掃描文字，請選擇此一項目。

### 照片

掃描照片時，請選擇此選項。



## 2.4 FILE FORMAT 印出檔案格式

Select the format of scanned data.

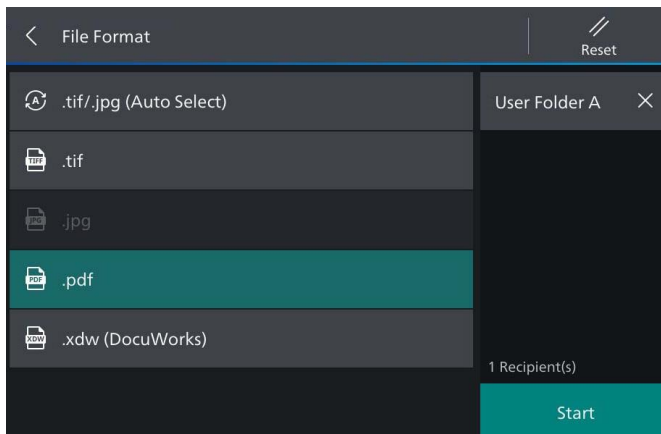
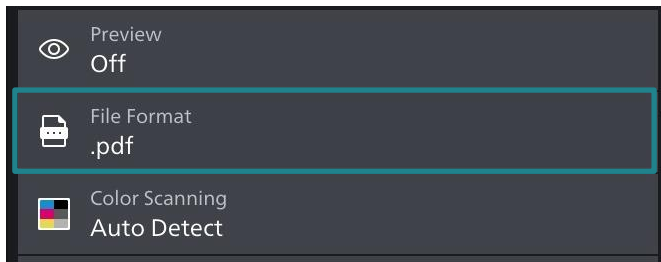

### TIFF/JPEG Auto Select

Automatically selects JPEG or TIFF. [JPEG] for full color and grayscale images, [TIFF] for black & white.

### TIFF

Saves multiple pages as 1 TIFF file.

### JPEG

Saves as a JPEG file.

### PDF

Saves as a PDF file.

### DocuWorks

Saves as a DocuWorks file.

選擇掃描資料的格式。

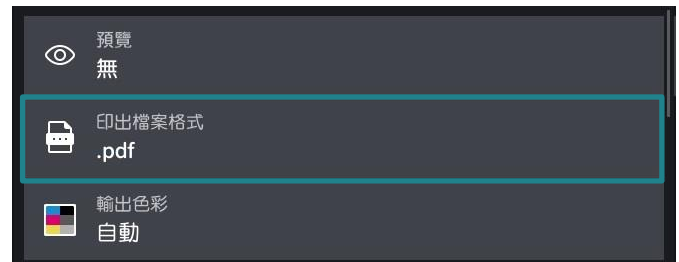

### TIFF/JPEG 自動

自動選取 JPEG 或 TIFF。全彩與灰階影像為【JPEG】，黑白則為【TIFF】。

### TIFF

以 1 個 TIFF 檔儲存多頁。

### JPEG

以 JPEG 檔儲存。

### PDF

以 PDF 檔儲存。

### DocuWorks

以 DocuWorks 檔儲存。

## 2.5 SINGLE FILE FOR EACH PAGE 每頁皆進行分割

Sets a single file for each page, and saves in the specified format.

每 1 頁 1 個檔案，以指定的檔案格式儲存。

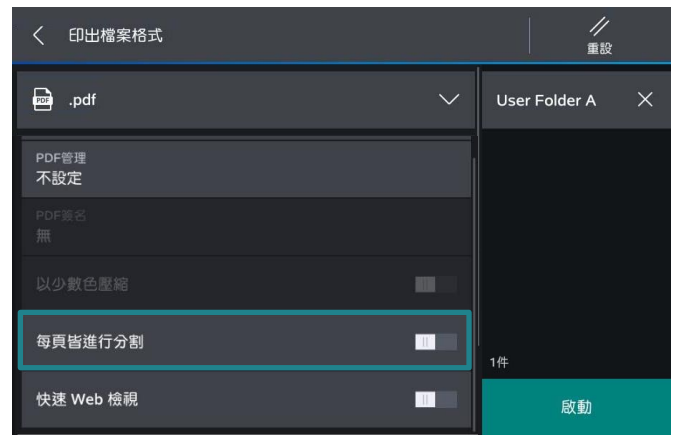
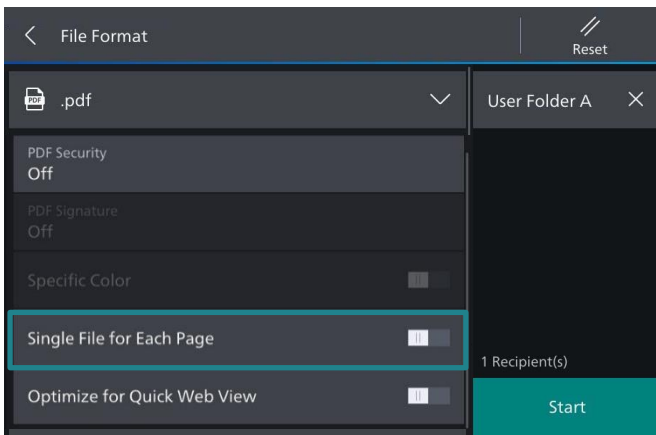
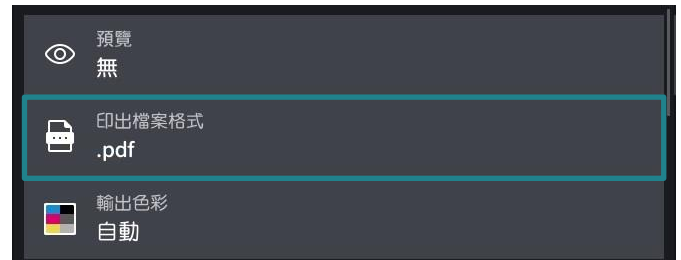
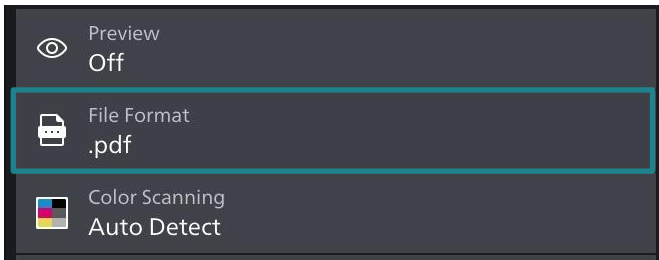

### Single File for Each Page

Saves each page as a single file in the specified format.

### 每頁皆進行分割

使用指定格式將各頁分別儲存為一個檔案。

## 2.6 RESOLUTION 解析度

Set the resolution for the documents to be scanned.

設定掃描原稿的解析度。

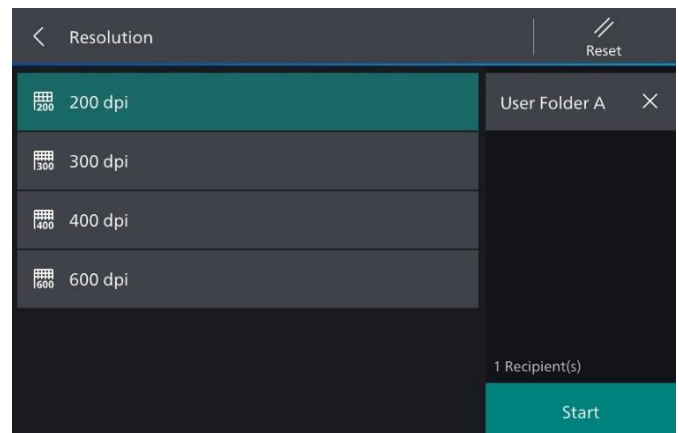
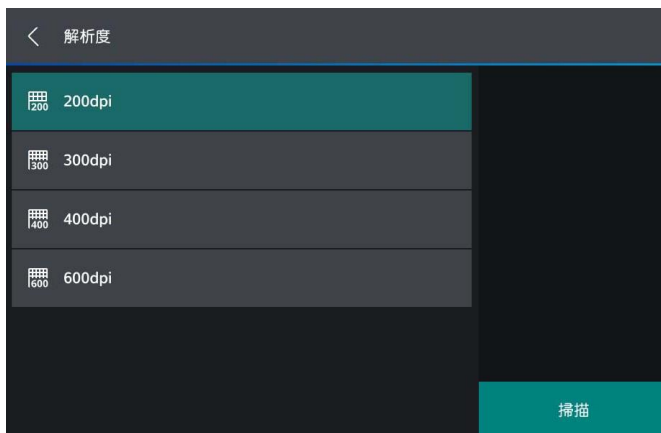
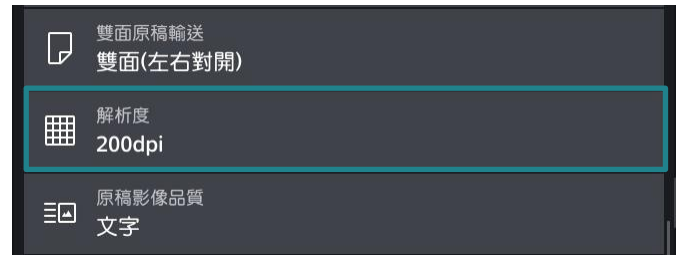
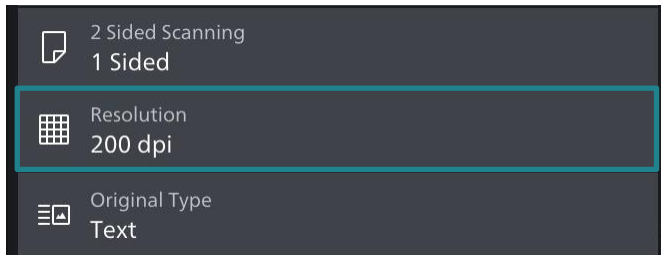

## 2.7 FILE NAME 檔案名稱

When using the [Email] or [Scan], you can specify the file name of the document to be sent.

使用【郵件送信】或【掃描】時，您可指定所發送檔案的名稱。

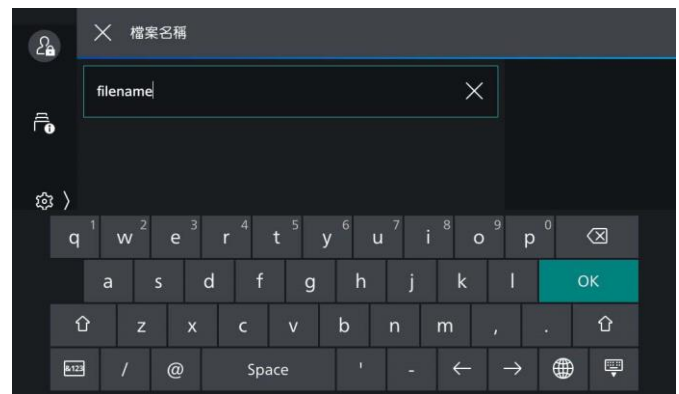
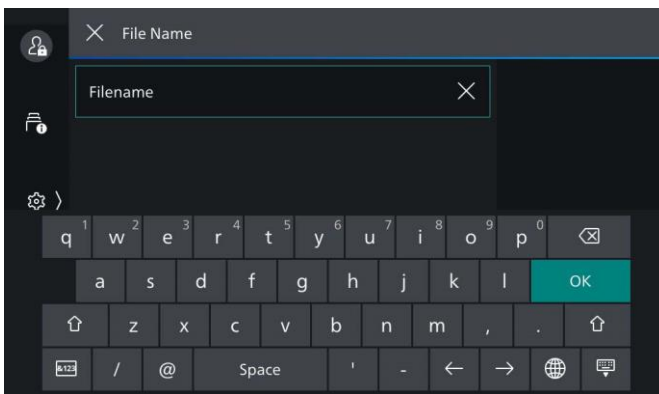
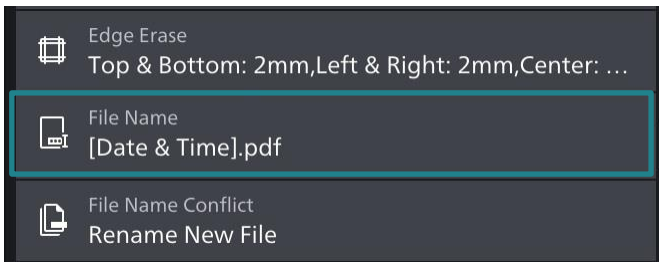

Use the displayed keyboard to enter a name up to 28 characters. Tap on [Start] when finished.

使用顯示出來的鍵盤輸入最多 28 個字元的名稱，然後點選【啟動】。

### 3 OPERATIONS DURING SCANNING 掃描期間的操作

#### 3.1 STOP THE SCAN JOB 停止掃描

1. Tap on [Pause] button on the touch screen.

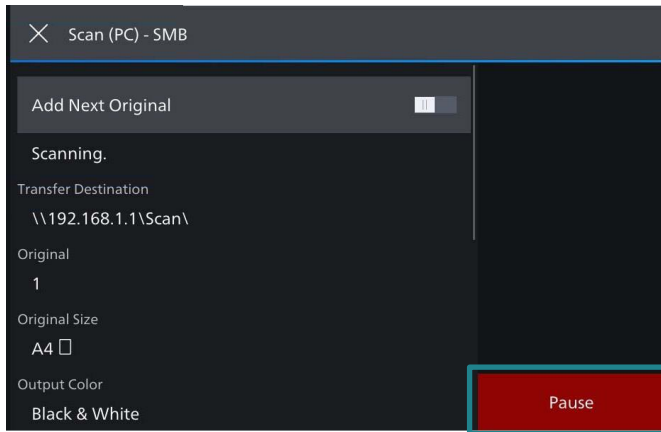

1. 點選顯示幕上的【停止】。

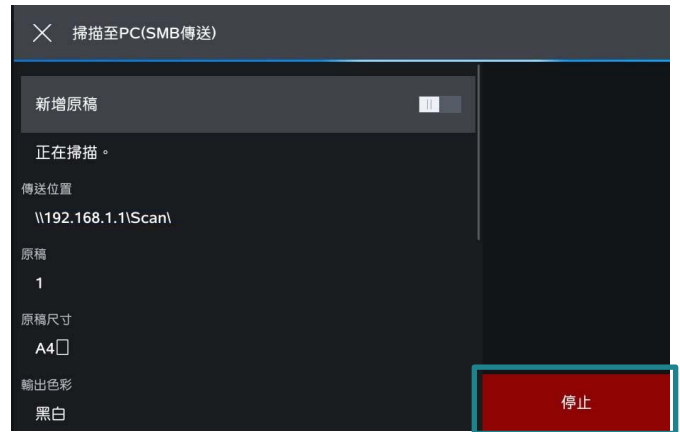

2. Tap on [Delete].

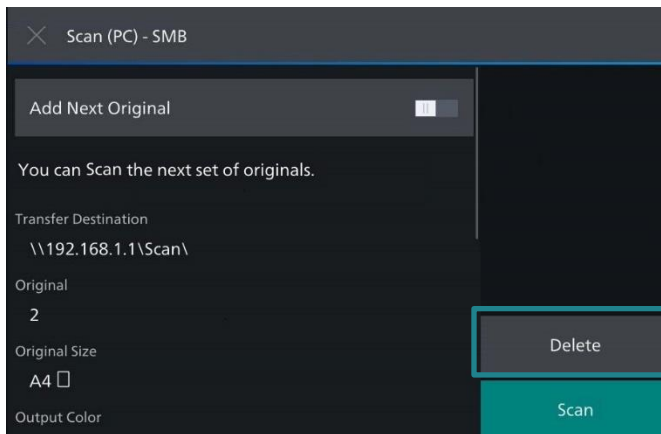

2. 再點選顯示幕上的【中止】。

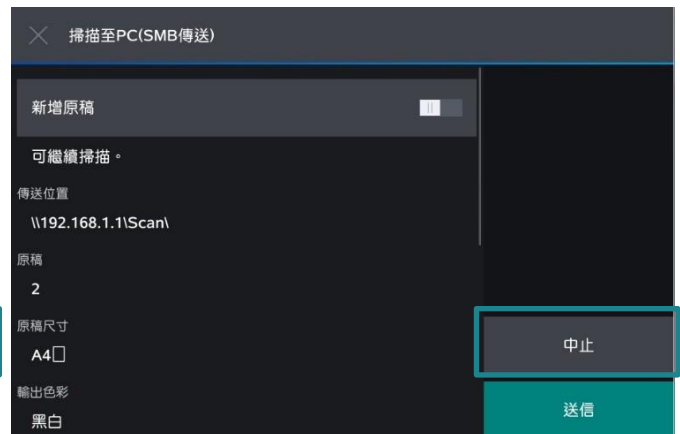

## 4 LOAD THE NEXT DOCUMENT 放置下一份原稿

If you have another document to scan, turn [Add Next Original] on while the current document is being scanned.

1. Select  while scanning is in progress.

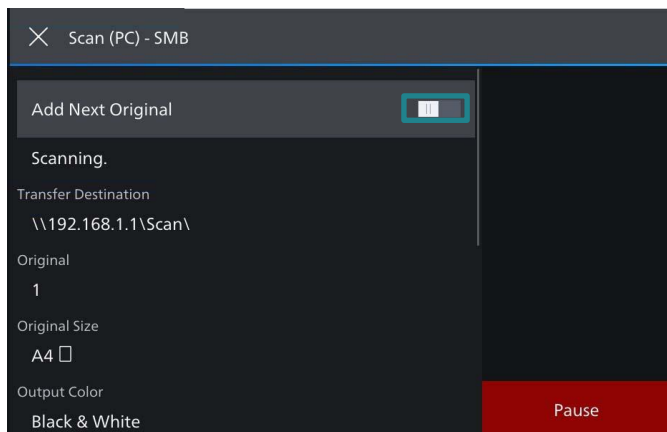

如果還有其他原稿需要掃描，請在掃描原稿時，在顯示幕上選擇【新增原稿】。

1. 請在掃描進行期間選擇 。

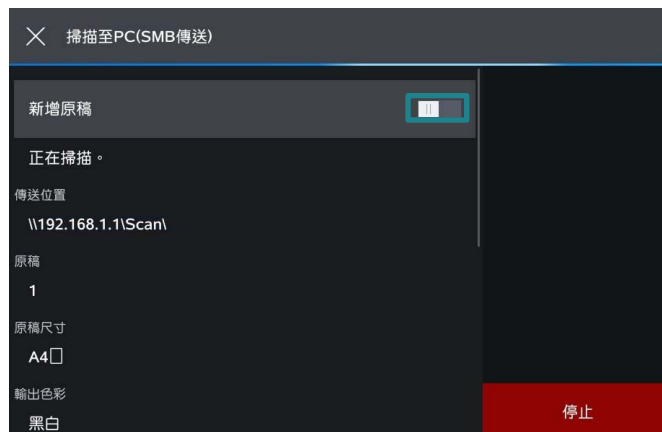

2. Load the next document, and then tap on [Scan].

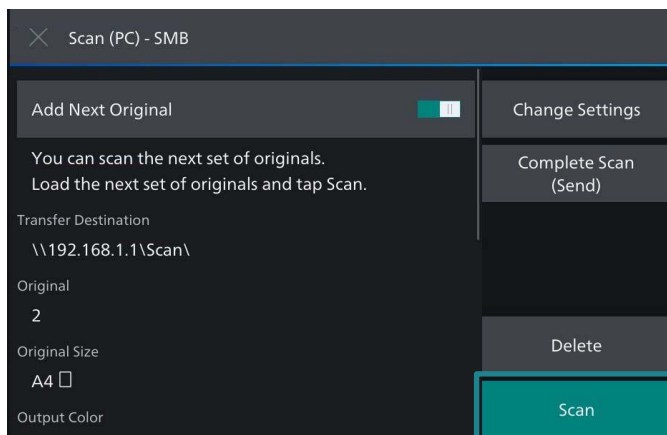

2. 放入下一份原稿，點選【掃描】。



3. When all documents scanned, select [Complete Scan (Send)].

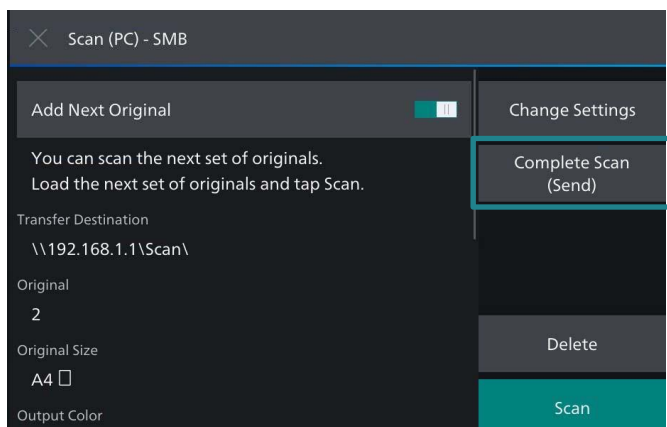

3. 所有原稿掃描之後，請選擇【完成掃描(送信)】。



## 5 SPECIAL FEATURES 特別功能

### 5.1 PREVIEWING AND ROTATING THE SCANNED IMAGES 預覽掃描及旋轉影像

You can preview and rotate the scanned images while scanning the document.

1. Tap on [Preview].

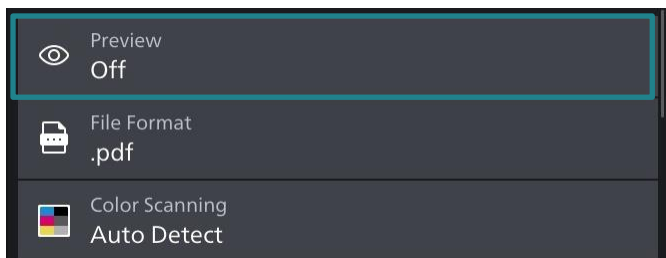

掃描文件時，您可以預覽及旋轉掃描影像。

1. 點選【預覽】。

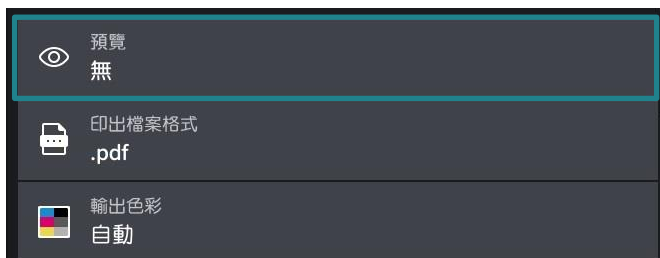

2. Tap on [On]. Then Tap on [Start].

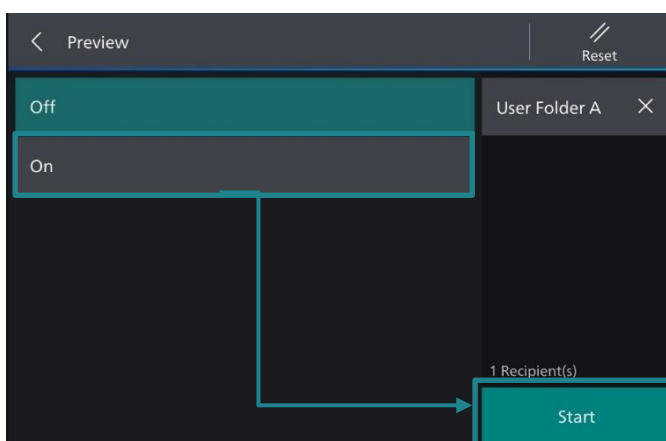

2. 點選【有】，然後點選【啟動】。

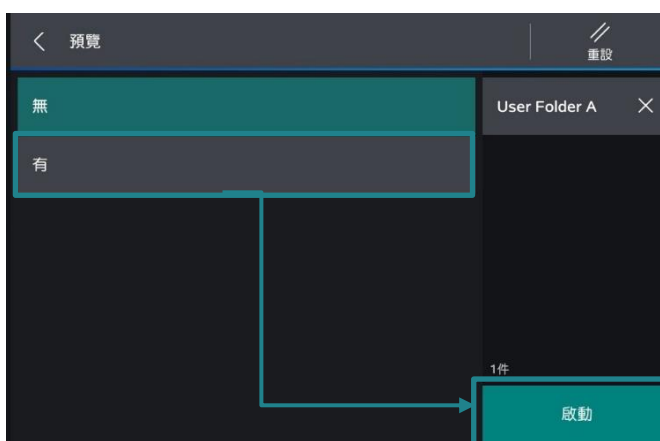

3. Select the pages and press [Rotate] to rotate the scanned image in correct direction.

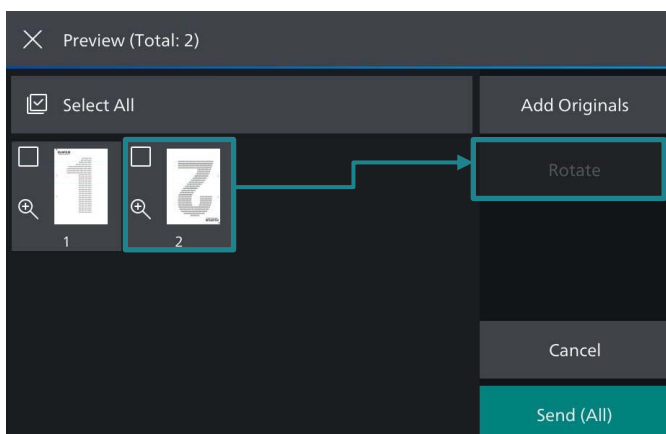

3. 選擇所需的文件頁面，然後按【旋轉】將文件頁面旋轉至正確的方向。

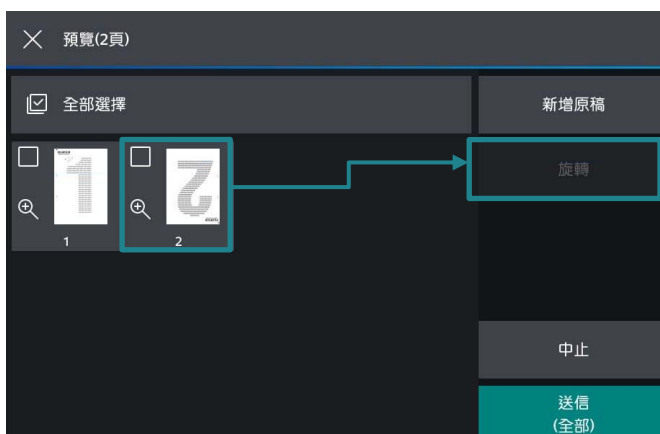

4. When you have finished preview and rotate the document, select [Send (All)].

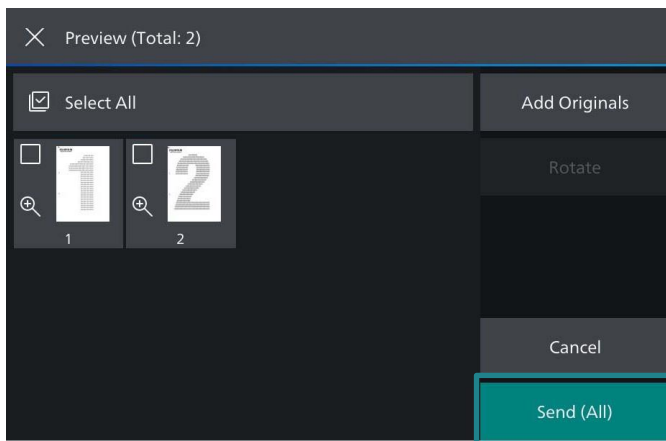

4. 當完成預覽及旋轉文件後，選擇【送信（全部）】。

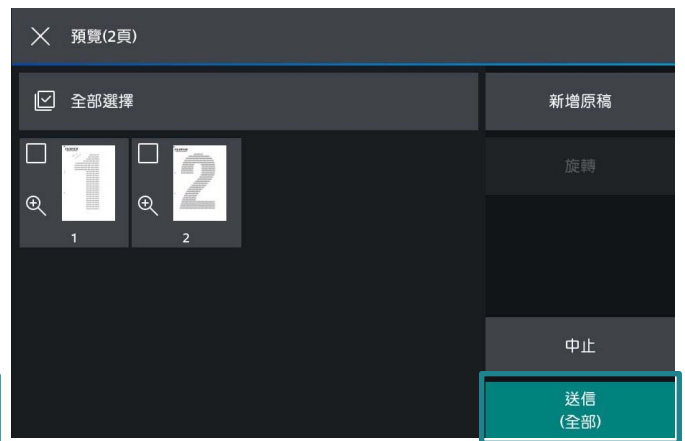



## 5.2 CHANGING THE SCAN SETTINGS DURING A SCAN JOB 掃描時改變掃描設定

1. Tap on [Preview].

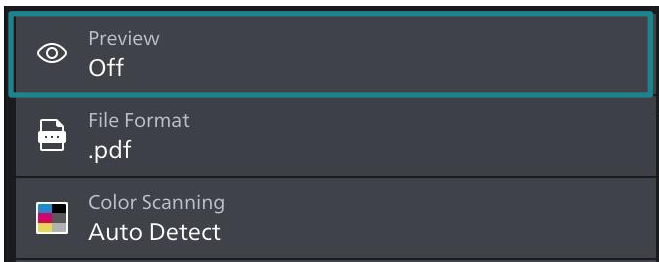

1. 點選【預覽】。

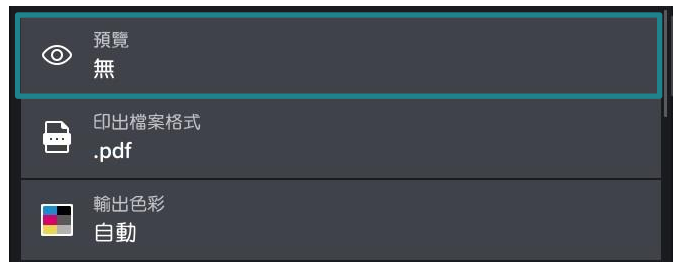

2. Tap on [On]. Then Tap on [Start].

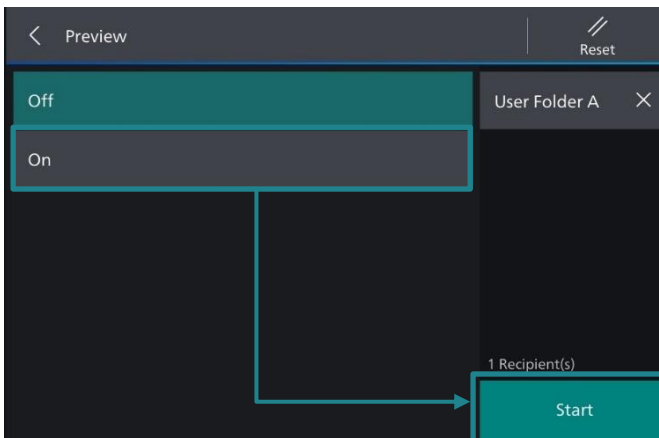

2. 點選【有】，然後點選【啟動】。

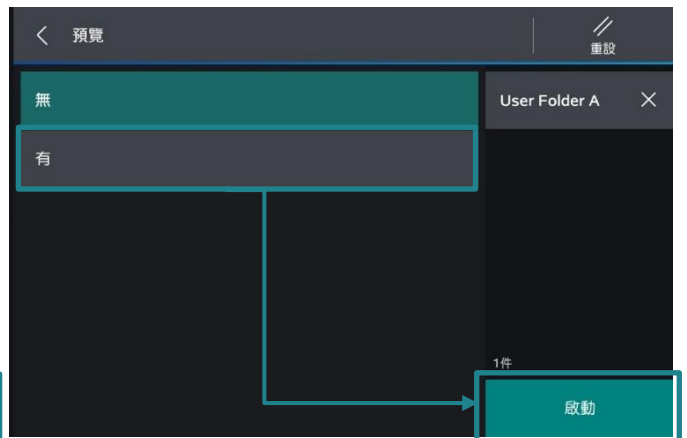

3. After the document scanned, tap on [Add Originals].

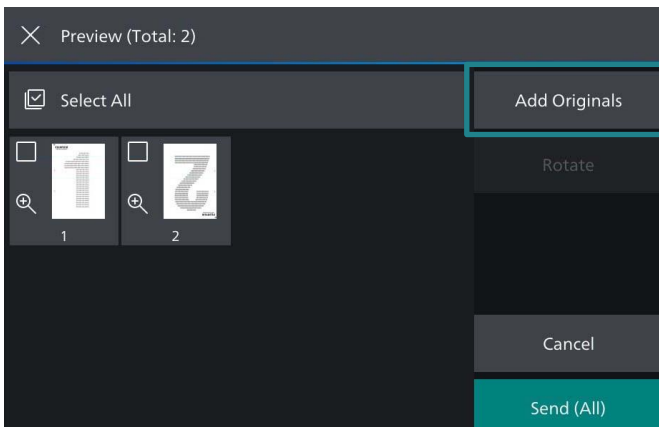

3. 文件掃描之後，點選【新增原稿】。

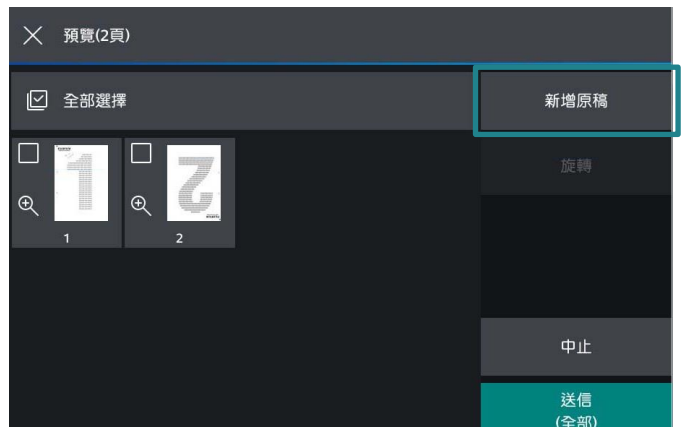

4. Tap on [Change Settings].

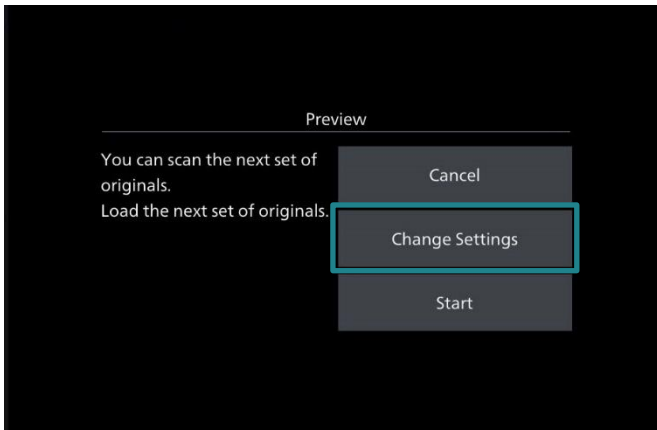

4. 點選【掃描設定】。

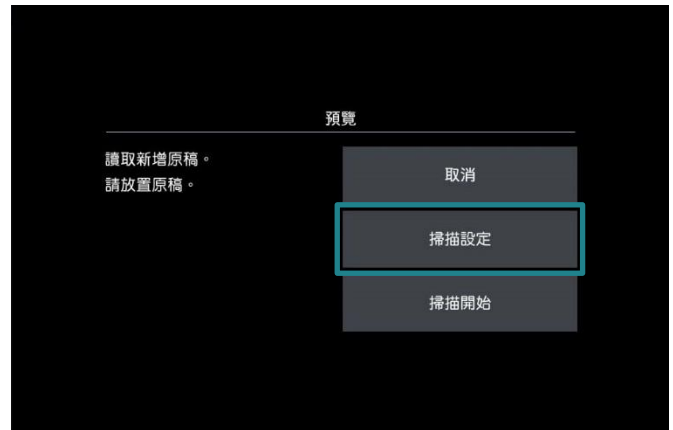

5. Change the scan settings, then tap on [Scan].

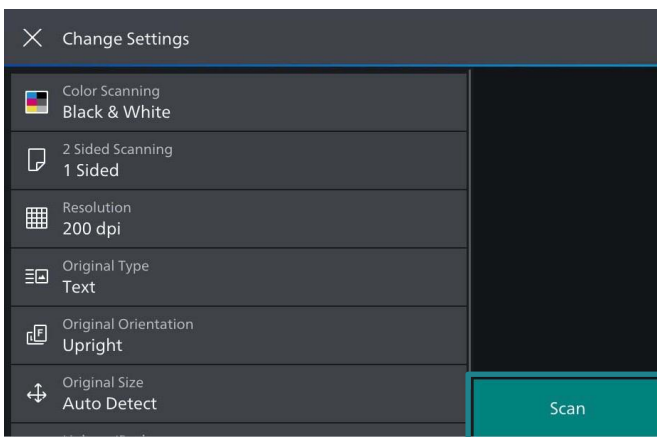

5. 變更掃描設定，點選【掃描】。



6. Ensure and preview all scanned documents, then tap on [Send (All)] to complete.

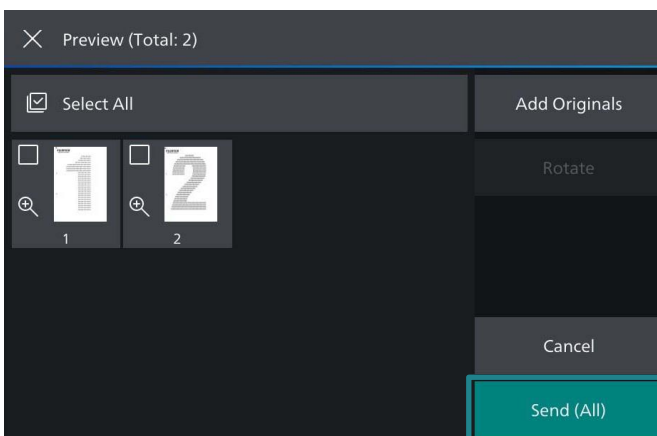

6. 確定並檢視所有掃描文件的預覽影像，然後點選【送信(全部)】完成掃描。

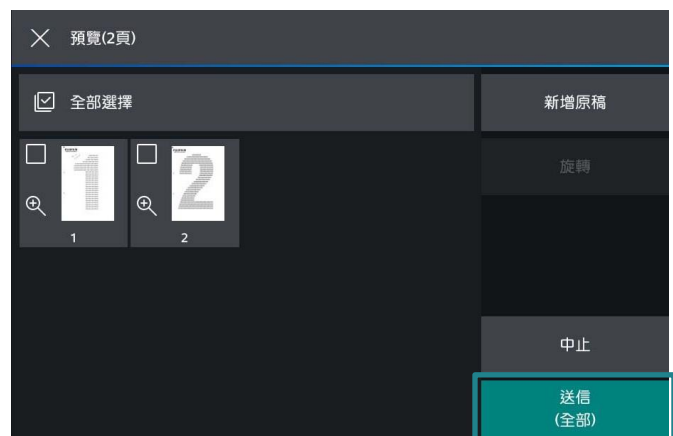

## 6 SCAN AUTO 自動掃描

Scan Auto can skip the blank pages and rotate the pages into correct orientation automatically.

1. Tap on [Scan Auto].

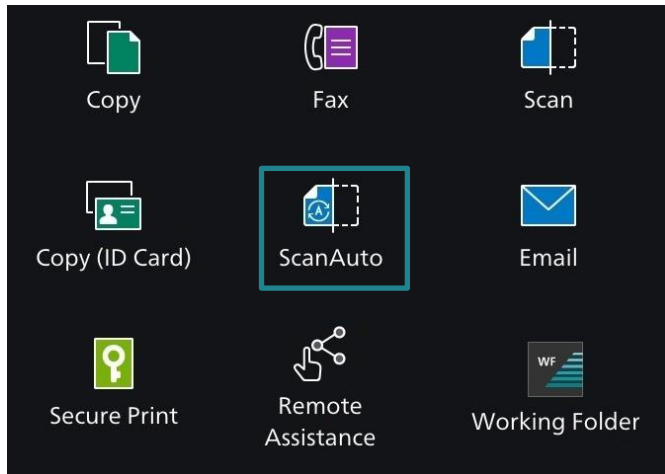



自動掃描能自動地把白頁去除及把頁面自動正立。

1. 點選【自動掃描】。

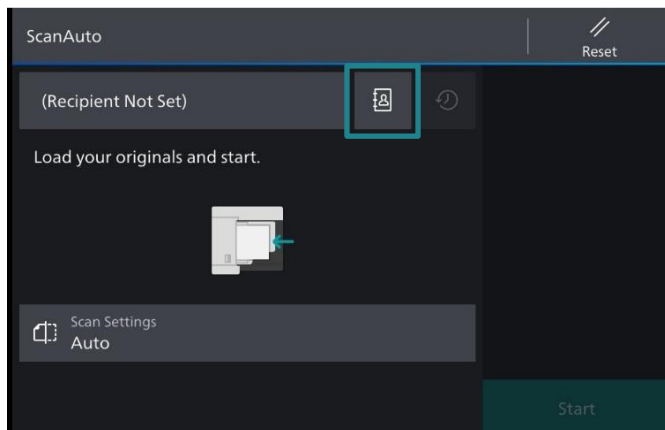

2. Specify recipient(s) using .



2. 選擇  並從地址清單選擇收件人地址。

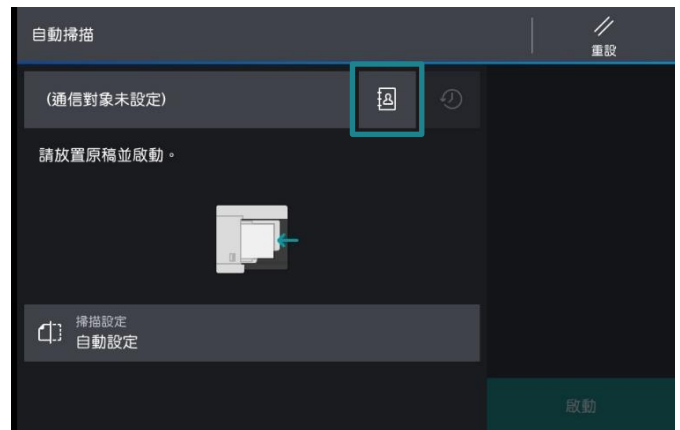

3. Choose the recipient(s). Then tap on [OK].

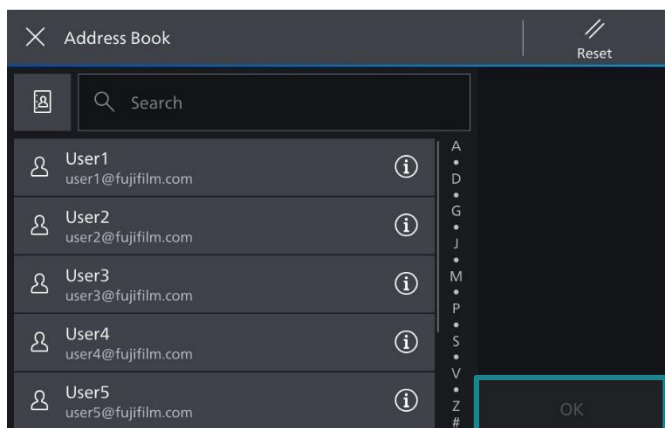

3. 選擇通訊對象。然後點選【OK】。

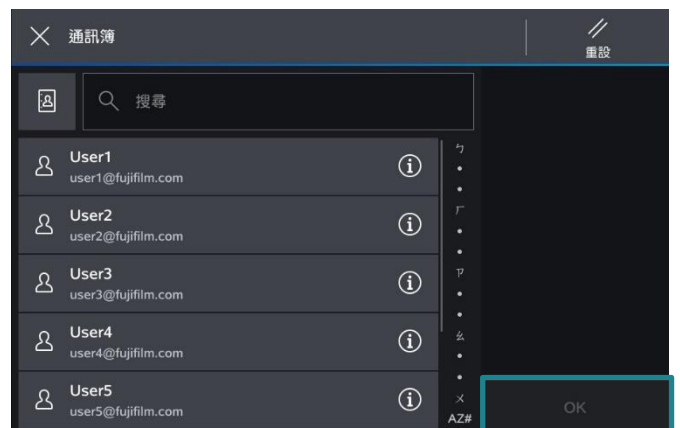

#### 4. Tap on [Start].

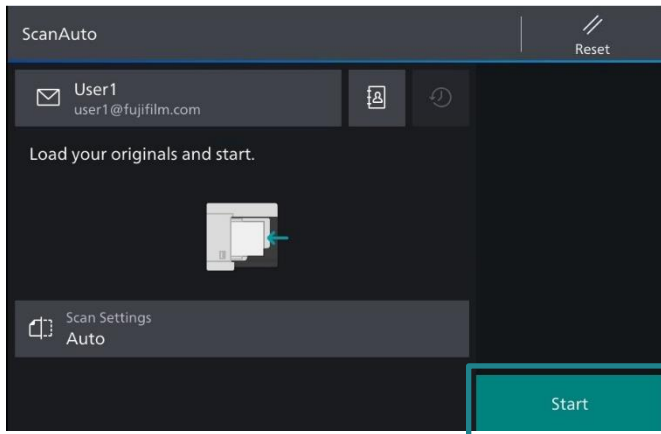

#### 4. 按【啟動】。

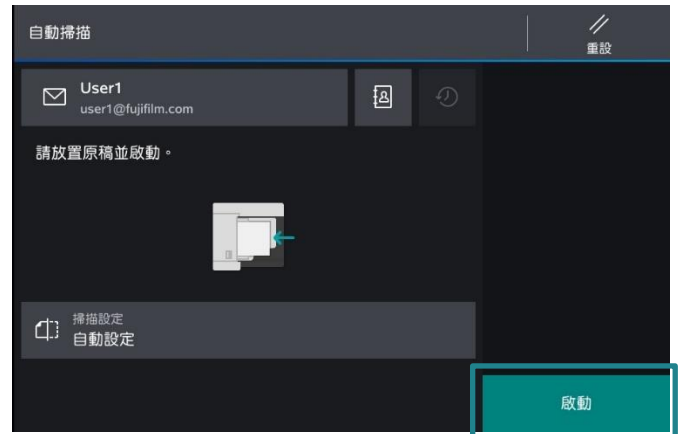

# Customer Support Center

## 2513-2513

FUJIFILM and FUJIFILM logo are registered trademarks or trademarks of FUJIFILM Corporation.

Apeos, ApeosPro, ApeosWiz, Working Folder is registered trademarks or trademarks of FUJIFILM Business Innovation Corp.

Adobe, Adobe logo, PostScript and PostScript logo are either registered trademarks or trademarks of Adobe in the United States and/or other countries.

Apple, AirPrint and Mac are trademarks of Apple Inc. registered in the U.S. and other countries.