

Quick Reference Notes - COPY

簡易操作 - 複印

ApeosPort® C3060 / C2060 / C2560

CONTENTS

目錄

1	Copy Procedure 複印步驟	2
1.1	Loading Documents 放置原稿	2
1.1.1	Document Feeder 自動送稿裝置	2
1.1.2	Document Glass 玻璃面板	2
1.2	Selecting Features (Copy) 選擇功能 (複印)	3
1.3	Entering the Quantity 輸入複印份數	4
2	Basic Copy Features 基本複印功能	5
2.1	Output Color 輸出色彩	5
2.2	2 Sided Copying 雙面/單面選擇	6
2.3	Paper Supply 紙張選擇	7
2.3.1	Tray 5 (Bypass) 紙盤 5 (手送紙盤)	8
2.4	Pages Per Side 多張合一 (N 合 1)	9
2.5	Copy Output 分頁/不分頁	10
2.6	Staple (OPTIONAL) 裝訂(額外購置)	11
2.7	Hole Punch (OPTIONAL) 打孔(額外購置)	12
2.8	Original Type 原稿類型	13
2.9	ID Card Copy / ID 卡複印	14
2.10	Non-Standard Size Original 規格以外的原稿尺寸	15
2.11	Operations During Copying 複印期間的操作	17
2.11.1	Stopping the Copy Job 停止複印	17
2.11.2	Load the Next Document 放置下一份原稿	18
2.11.3	Interrupting the Copy Job 插印作業	19

1 COPY PROCEDURE 複印步驟

1.1 LOADING DOCUMENTS 放置原稿

1.1.1 Document Feeder 自動送稿裝置

Remove any paper clips and staples before loading a document.

放置文件前，請取下萬字夾和清走打釘。

1. Load the document face up (when the document is 2-sided, place the front side up) in the center of the document feeder.

1. 將文件正面朝上 (若是雙面文件，將正面朝上) 放置在送稿裝置的中央。

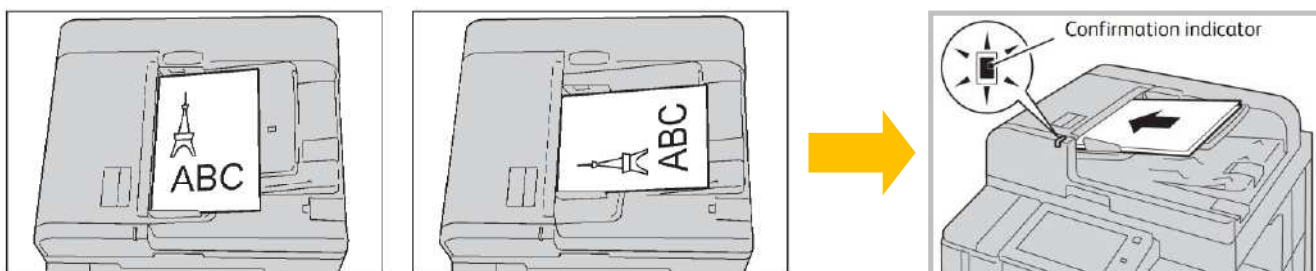

2. Adjust the document guides to match the size of the document loaded. Raise the document stopper.

2. 調整原稿調整桿至符合紙張尺寸，抬起擋紙器。

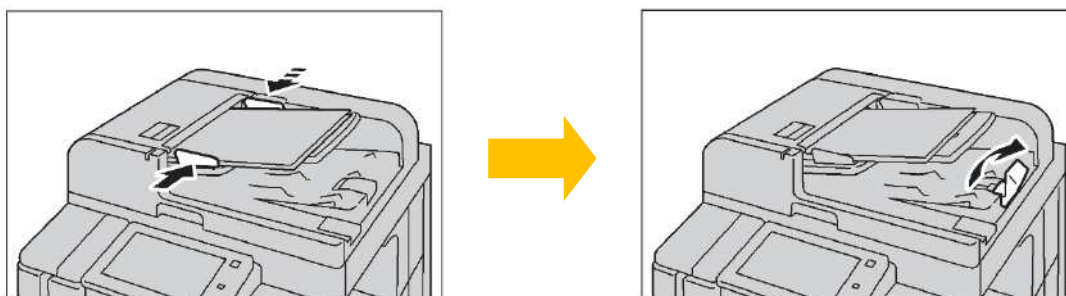

1.1.2 Document Glass 玻璃面板

1. Open the document cover.
2. Load the document face down, and align it against the top left corner of the document glass. Close the document cover.

1. 開啟原稿外蓋。
2. 將文件的正面朝下，對準玻璃面板的左上角放置並關閉原稿外蓋。

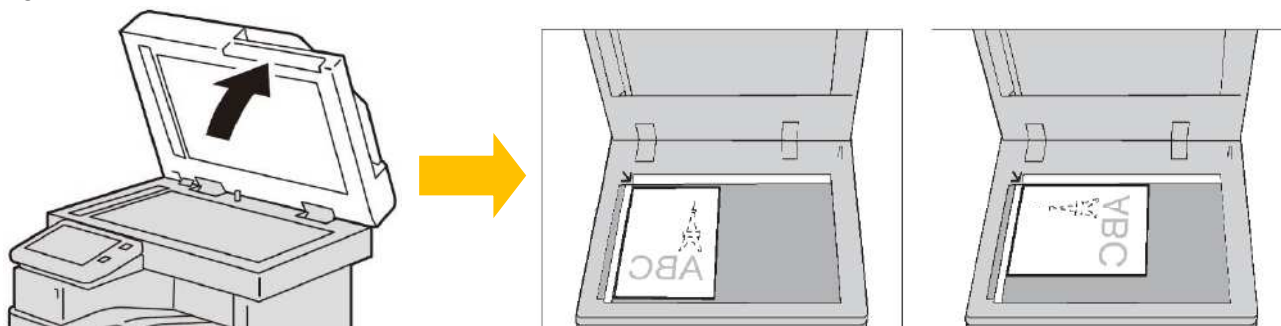

1.2 SELECTING FEATURES (COPY) 選擇功能 (複印)

1. Press the Home button.



1. 按一下首頁按鈕。



2. Select [Copy].

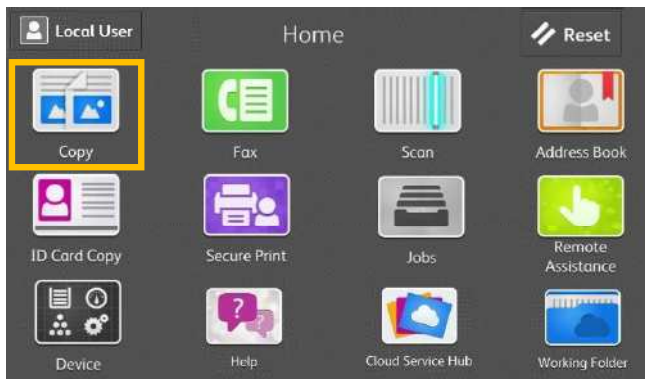

2. 選擇【複印】。



3. Configure necessary features.

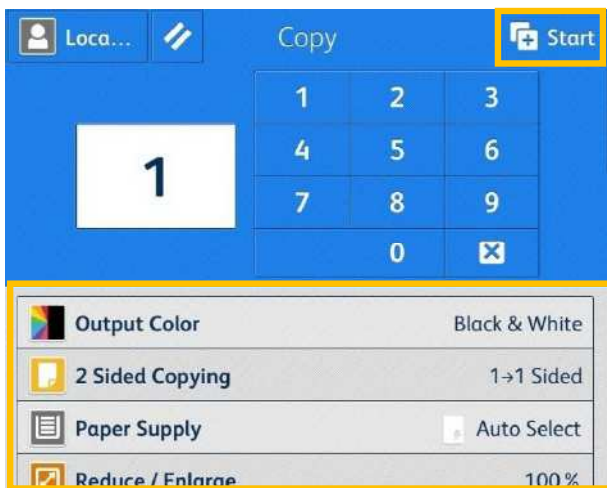

4. Press [Start] to copy.

3. 設置所需功能。



4. 按【啟動】開始複印。

1.3 ENTERING THE QUANTITY 輸入複印份數

Entering the number of copies.

輸入複印份數。



If you have entered an incorrect value, press  and enter the correct value.

如輸入錯誤數值，按  並輸入正確的數值。

Note: You can enter up to 999 for the number of copies.

補充：最多可輸入 999 複印數。

2 BASIC COPY FEATURES 基本複印功能

2.1 OUTPUT COLOR 輸出色彩



Auto Detect

Make copies in full color if the original is color, and in one color (black) if the document is black and white.

Color

Copies in full color.

Black & White

Black & white output only.

Dual Color, Red/Black

Output copy in two preset colors.

Single Color, Red

Copies color documents using one color.

自動

本機自動判定原稿的色彩，讓彩色原稿進行全彩複印，讓黑白原稿進行單色 (黑色) 複印。

全彩

以全彩複印。

黑白

以黑白複印。

雙色 (紅色/ 黑色)

使用二種顏色複印彩色原稿。

單彩 (紅色)

以單一顏色複印彩色原稿。

2.2 2 SIDED COPYING 雙面/單面選擇



1→1 Sided

Makes a copy of a 1-sided document on one side of the paper.



1→2 Sided

Makes a copy of a 1-sided document on both sides of the paper.



2→2 Sided

Makes a copy of a 2-sided document on both sides of the paper.



2→1 Sided

Makes a copy of a 2-sided document on one side of the paper.



Head to Head

Select this option when you want the orientation of the front and back sides of the copy to be the same as that of the document.



Head to Toe

Select this option when you want the orientation of the front and back sides of the copy to be the opposite of that of the document.



單面→單面

將單面原稿複印於紙張的單面。



單面→雙面

將單面原稿複印於紙張的兩面。



雙面→雙面

將雙面原稿複印於紙張的兩面。



雙面→單面

將雙面原稿複印於紙張的單面。



左右對開

當您希望複本的正面和反面的方向與文件方向相同時，請選擇此項。



上下對開

當您希望複本的正面和反面的方向與文件方向相反時，請選擇此項。



2.3 PAPER SUPPLY 紙張選擇



Auto

The paper type of all the trays are default as plain paper, if one tray is out of paper, it will select the tray with the same paper size automatically.

Note: If the original size is different from the paper tray, you must select the tray.

自動

所有紙盤的紙張類型默認為普通紙，如果一個紙盤缺紙，則會自動選擇相同紙張尺寸的紙盤。

注意：如果原稿尺寸與紙盤的紙張尺寸不同，則必須選擇紙盤。

2.3.1 Tray 5 (Bypass) 紙盤 5 (手送紙盤)

If you want to make copies on paper that cannot be loaded in Trays 1, use Tray 5 (Bypass).

1. Load paper with the side to be copied or printed on facing downward. Insert the paper until its edge lightly touches against the paper feed entrance.

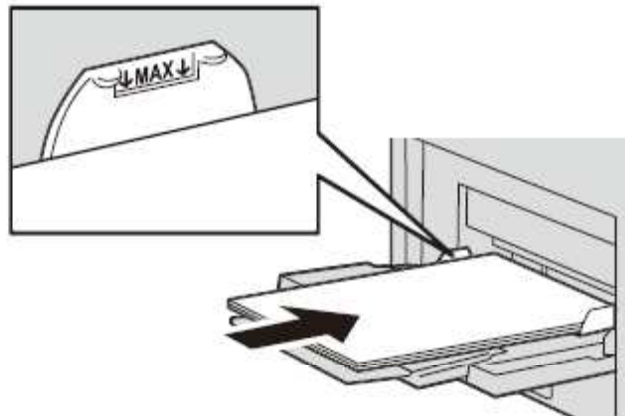

無法置入紙盤 1 的紙張，請置入紙盤 5 (手送紙盤) 中進行複印。

1. 放置紙張，要複印或列印的一面朝下，將紙張輕輕插入紙張進紙入口處。

2. Select [Tray 5] from [Paper Supply] screen.



2. 於【紙盤】畫面，選擇【紙盤 5】。



2.4 PAGES PER SIDE 多張合一 (N 合 1)

This feature allows you to copy two, four, or eight pages of a document together onto a single sheet of paper.

此功能可將 2 頁、4 頁或 8 頁複印在同一張紙上。

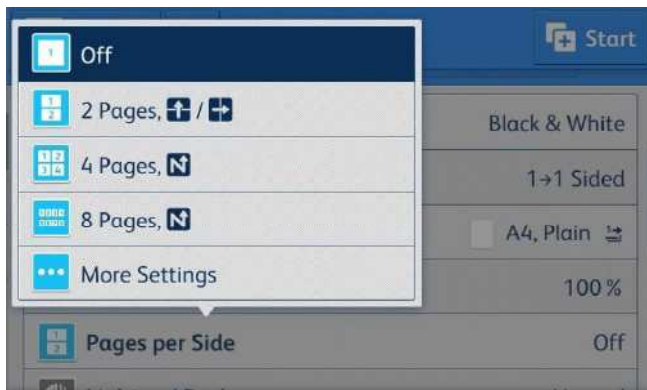

2 Pages Up

Two pages are copied together onto a single page



4 Pages Up

Four pages are copied together onto a single page



8 Pages Up

Eight pages are copied together onto a single page



2 張 → 1 張 (2 合 1)

將 2 張原稿複印於同一張紙上。



4 張 → 1 張 (4 合 1)

將 4 張原稿複印於同一張紙上。



8 張 → 1 張 (8 合 1)

將 8 張原稿複印於同一張紙上。



2.5 COPY OUTPUT 分頁/不分頁

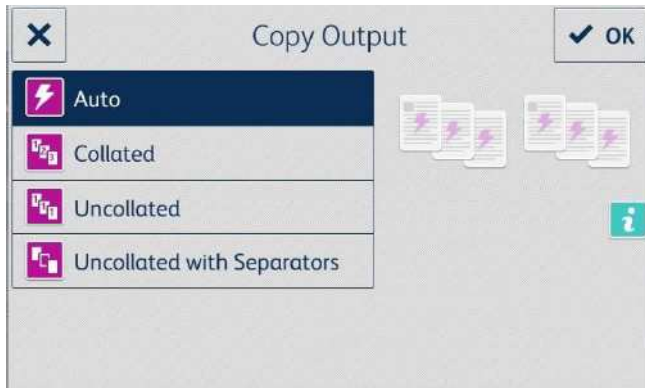
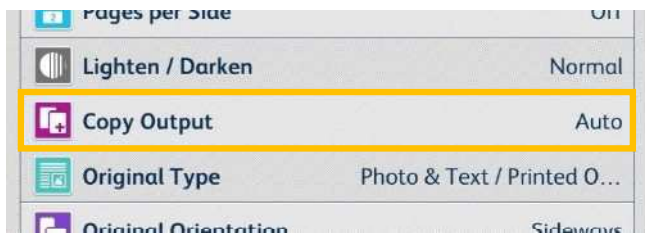

Auto

Copies are output collated when using auto document feeder

Collated

The machine outputs sheets sorted into sets that are arranged in page order. 

Uncollated

The machine outputs the specified number of copies and sorts sheets by page. 

Uncollated with Separators

The machine outputs copies with inserting blank sheets as a separator and sorts sheets by page.

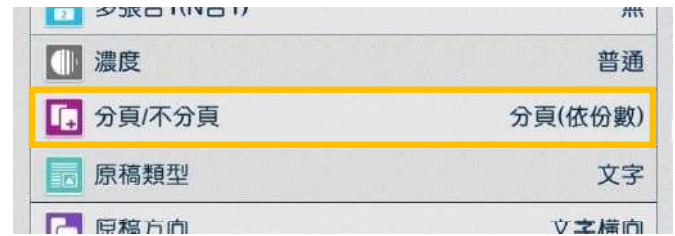

自動

當原稿放置在送稿裝置中時，複本將分頁。

分頁 (依份數)

本機會依頁面順序分頁輸出整份複本。 

不分頁(依頁號)

本機會輸出指定的複本數量，並依頁面順序排序。 

不分頁+襯紙

本機會在輸出的複本中插入空白紙作為襯紙，並按照頁面順序排序。

2.6 STAPLE (OPTIONAL) 裝訂(額外購置)

This feature allows you to set the position for stapling.

Note: This feature is optional.

此功能可供您選擇裝訂的位置。

注意：需額外購置。

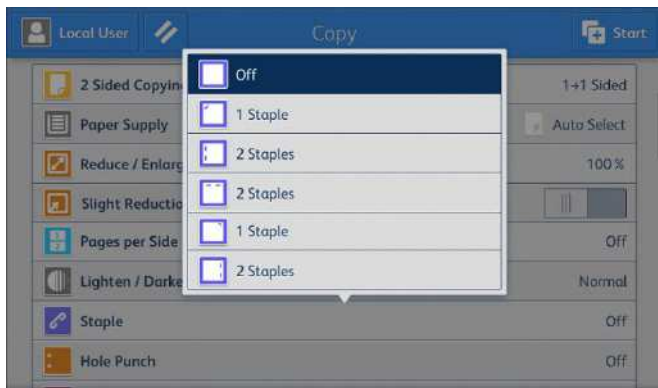
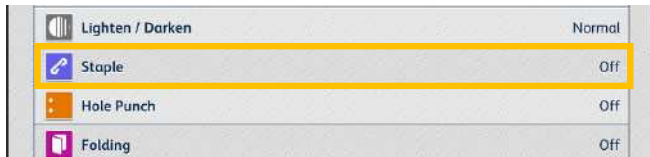

Staple - The number of sheets that can be stapled is 2 – 50. (when 80 gsm paper is used).

裝釘 – 可裝訂的張數為 2-50 張 (使用 80 gsm 紙張時)。

2.7 HOLE PUNCH (OPTIONAL) 打孔(額外購置)

This feature allows you to set the position of the hole punch.

此功能可供您選擇打孔的位置。

Note: This feature is optional.

注意：需額外購置。

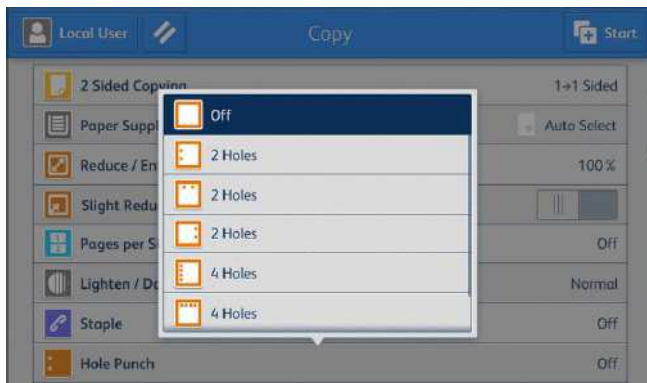
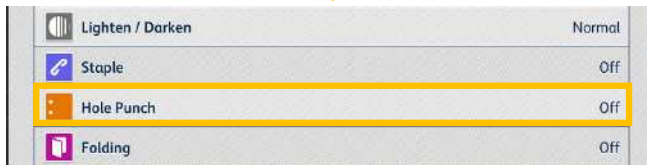

Hole Punch – 2 holes or 4 holes is available for selection.

打孔 – 兩孔或四孔可選擇。

2.8 ORIGINAL TYPE 原稿類型

This feature allows you to select the type of documents, such as text and photos. By selecting a document type, you can make copies at optimum image quality.

1. Select [Original Type].



Photo & Text

Select this option when the document contains both text and photos.

Text

Select this option to make copies of text.

Photo

Select this option to make copies of photos.

此功能可供您選擇文件種類，例如文字和照片。藉由選擇文件種類，您可使用最理想的畫質進行複印。

1. 選擇【原稿類型】。

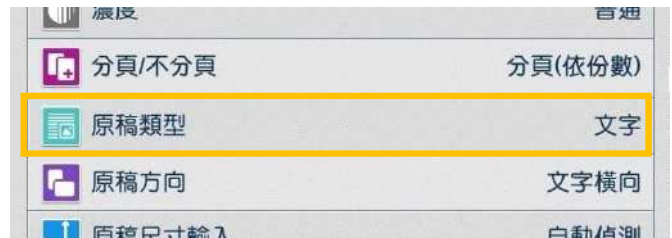

文字/照片

文件包含文字和照片時，請選擇此選項。

文字

複印文字原稿時，請選擇此選項。

照片

複印照片時，請選擇此選項。

2.9 ID CARD COPY / ID 卡複印

This feature allows you to copy both sides of a small undetectable original, such as an ID card, onto one side of paper.

此功能可供您將無法偵測的小型文件 (如身份證) 的正背面複印至同一面紙張上。

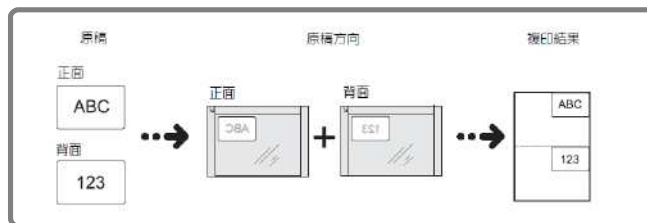
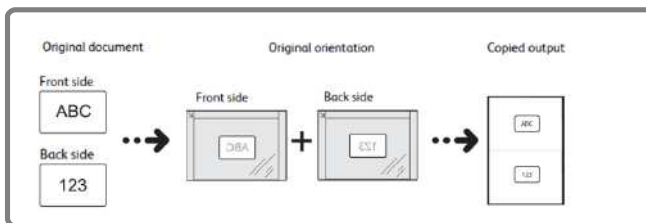

1. Select [ID Card Copy].

1. 選擇【ID 卡複印】。



2. Place the ID Card on document glass, then press [Scan], copy the front side of the card as usual.

2. 放置文件於玻璃面板，然後按【掃描】，如常複印文件的正面。



3. Turn the card over without changing its position and press [Scan] to copy the back side of the card.

3. 翻轉文件於正面相同位置上，按【掃描】複印文件的背面。

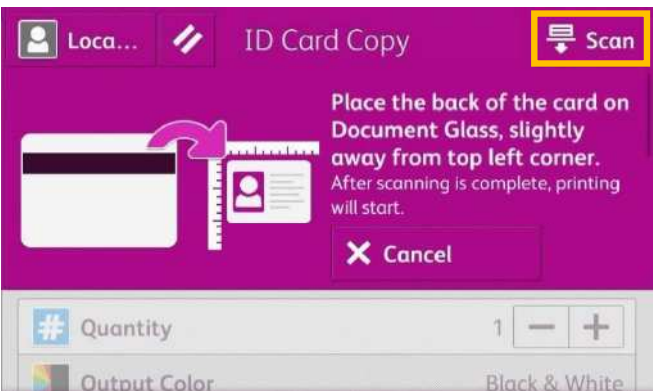

2.10 NON-STANDARD SIZE ORIGINAL 規格以外的原稿尺寸

When a document is of non-standard size, and the output needs fit to the paper size, follow the steps below.

1. Select [Reduce / Enlarge], and then choose [Auto%].



2. Select [Paper Supply], and then choose the tray you need.

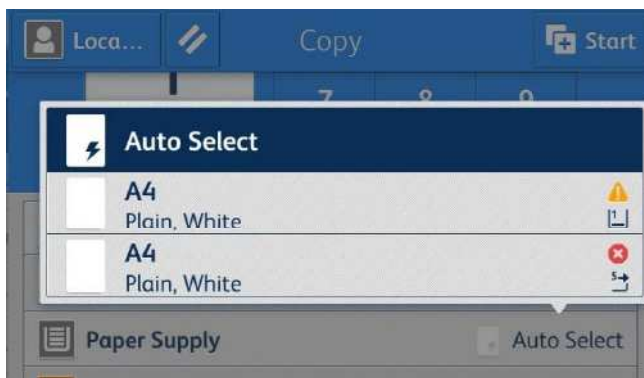

當文件為規格以外的尺寸，而複本需要符合紙盤的紙張大小時，請根據以下操作。

1. 選擇【放大/縮小】，然後選擇【自動%】。



2. 選擇【紙張選擇】，然後選擇所需紙盤。

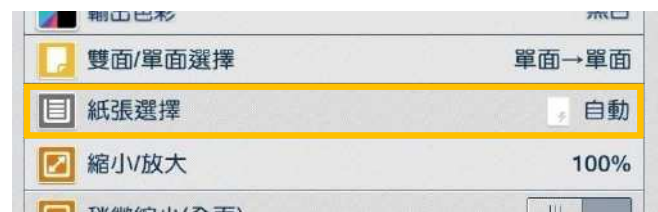

3. Select [Original Size], and specify values for the X and Y dimensions, then select [OK].



3. 選擇【原稿尺寸輸入】，輸入橫向和縱向的數值然後選擇【OK】。

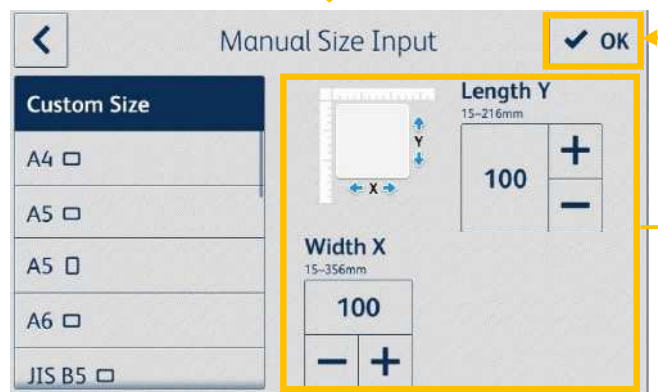
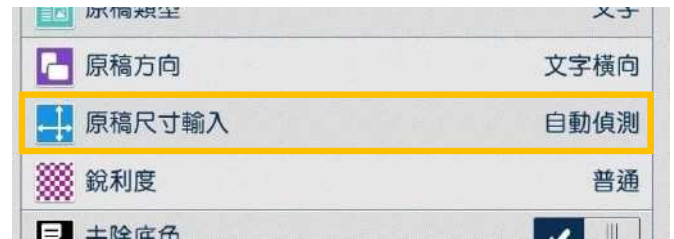

Note: The original orientation must be as same as that of the output tray.



注意：原稿放置方向必須與選擇紙盤一致。

5. Press [Start] to copy.

5. 按【啟動】開始複印。

2.11 OPERATIONS DURING COPYING 複印期間的操作

2.11.1 Stopping the Copy Job 停止複印

1. Select [Pause] on the touch screen.

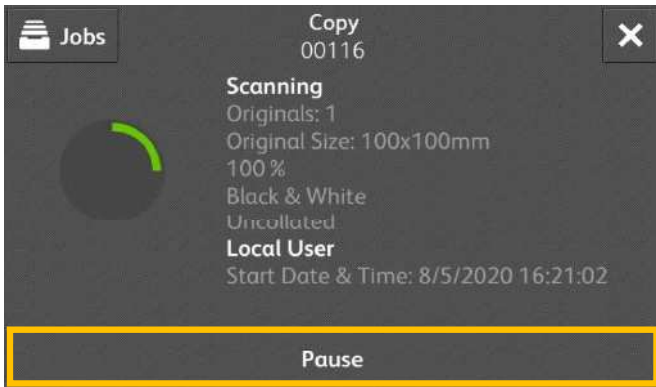

1. 在觸控屏幕上選擇【停止】。



2. Select [Delete] on the touch screen.

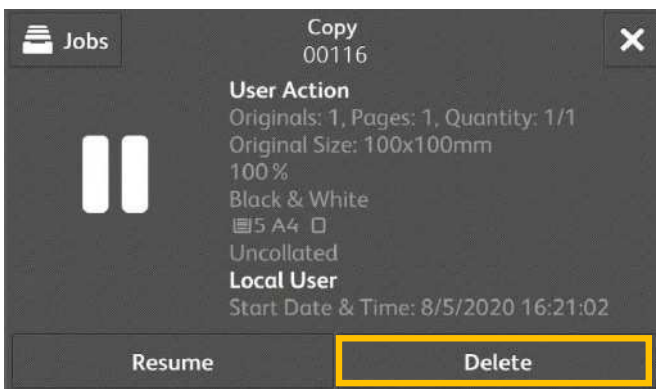

2. 在觸控屏幕上選擇【中止】。

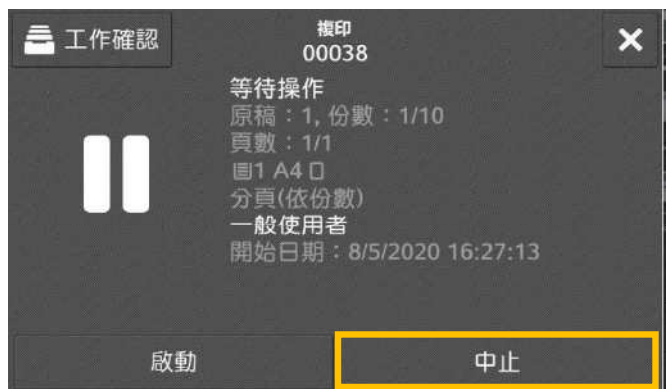

2.11.2 Load the Next Document 放置下一份原稿

If you have more documents to copy, select [Next Original] on the touch screen while the current document is being scanned. This allows you to scan the documents as a single set of data.

1. Select [On] while scanning is in progress.

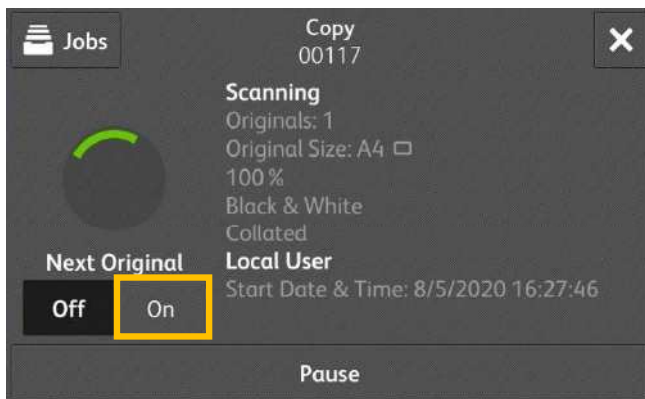

若還有其他文件要影印，請在掃描文件時在觸控式顯示面板上選擇【下一張原稿】。如此可將文件視為一份資料而進行掃描。

1. 請在掃描進行期間選擇【有】。



2. Load the next document, and then press [Scan Next Original].

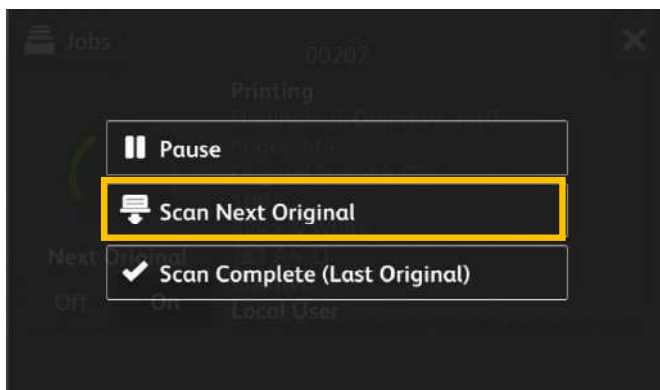

2. 放入下一份原稿, 按【掃描下一張原稿】。



3. When all documents have been scanned, select [Scan Complete (Last Original)].

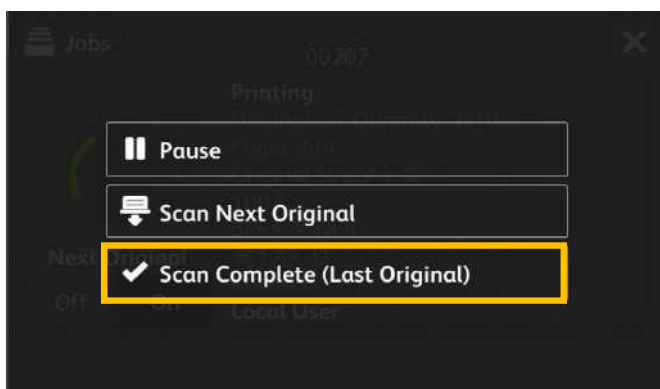

3. 已掃描所有文件後，選擇【掃描完成(無下一張原稿)】。



2.11.3 Interrupting the Copy Job 插印作業

You can temporarily stop the copy job to let the machine process another job first.

1. Select  on the top right corner.

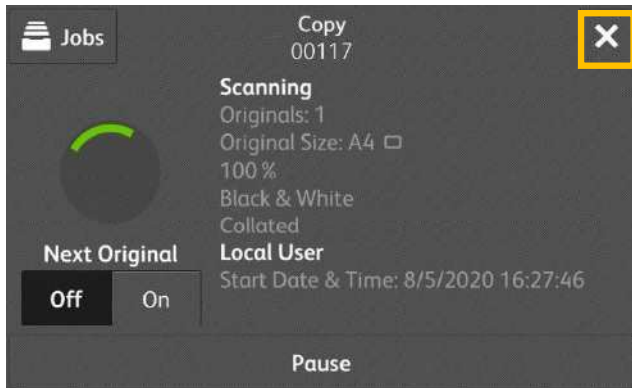

您可以暫時停止複印工作，讓本機先處理另一個工作。

1. 請選擇右上方的 。



2. Select  and [Interrupt] to stop the copy job temporarily.



2. 選擇  及【插印】，暫時停止複印工作。

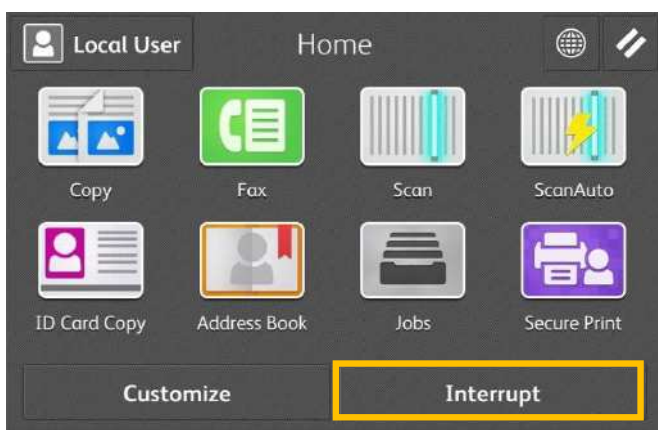

3. Select [Copy].



3. 選擇【複印】。



4. Configure necessary features and select [Start].



4. 設置所需功能然後選擇【啟動】。

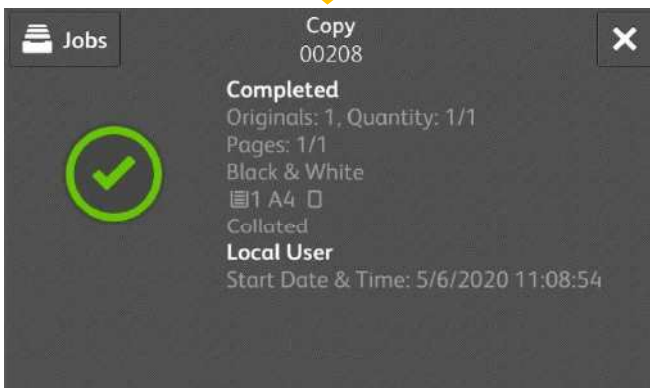

5. After you have finished making the copy, select [Cancel Interrupt] again. The suspended copy job is resumed.

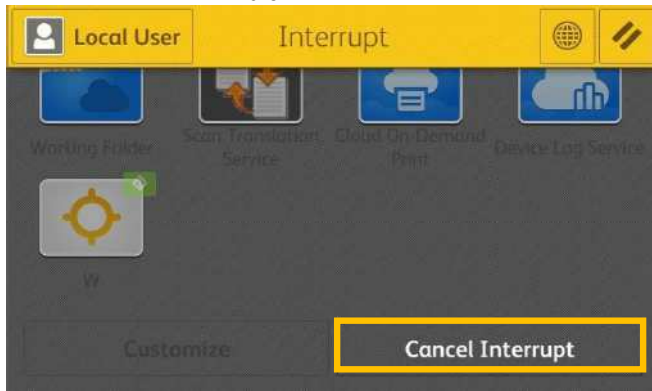

5. 完成插印作業之後，再選擇一次【解除插印】，即恢復中斷的複印工作。



Customer Support Center

2513-2513