

Quick Reference Notes - Fax

簡易操作 – 傳真

ApeosPort® C3060 / C2060 / C2560

CONTENTS

目錄

1	Fax Procedure 傳真步驟.....	2
1.1	Loading Document 放置原稿.....	2
1.1.1	Document Feeder 自動送稿裝置.....	2
1.1.2	Document Glass 玻璃面板.....	2
1.2	Specifying Destinations 選擇指定通訊目的地.....	3
1.2.1	Using the Numeric Keypad 使用數字鍵.....	4
1.2.2	Using the Address Book 使用電話簿.....	5
1.2.3	Removing Specified Recipient 刪除指定的受信方.....	6
1.3	Confirming the Fax Job in Job Status 確認傳真工作.....	7
2	General Settings 基本傳真.....	8
2.1	Lighten/Darken 濃度.....	8
2.2	2 Sided Scanning 雙面原稿輸送.....	9
2.3	Original Type 原稿畫質.....	10
2.4	Resolution 送信畫質.....	11
2.5	Acknowledgement Report 送信確認報表.....	12
2.6	Transmission Header Text 發信方記錄.....	13
2.7	On-hook 免持聽筒.....	14
3	Operations During Faxing 傳真期間的操作.....	15
3.1	Stopping the Fax Job 停止傳真.....	15
3.2	Previewing the Read Images during a Fax Job 傳真時預覽讀取的影像.....	17
4	Load the Next Document 放置下一份原稿.....	18

1 FAX PROCEDURE 傳真步驟

1.1 LOADING DOCUMENT 放置原稿

1.1.1 Document Feeder 自動送稿裝置

Remove any paper clips and staples before loading a document.

1. Adjust the document guides to match the size of the document loaded. Raise the document stopper.
2. Load the document face up (when the document is 2- sided, place the front side up) in the center of the document feeder.

放置文件前，請取下萬字夾和清走打釘。

1. 調整原稿調整桿至符合紙張尺寸，抬起擋紙器。
2. 將文件正面朝上 (若是雙面文件，將正面朝上) 放置在送稿裝置的中央。

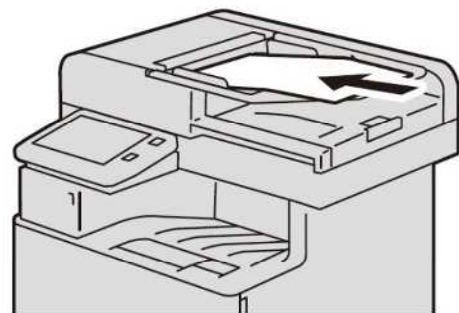
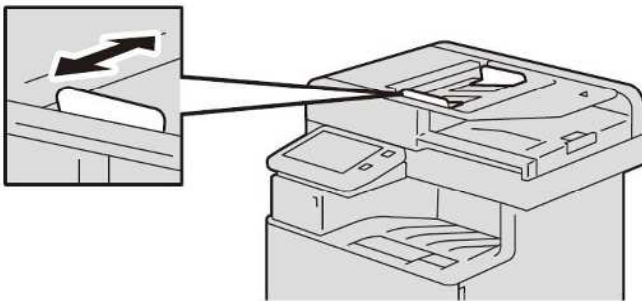

1.1.2 Document Glass 玻璃面板

1. Open the document cover.
2. Load the document face down, and align it against the top left corner of the document glass. Close the document cover.

1. 開啟原稿外蓋。
2. 將文件的正面朝下，對準玻璃面板的左上角放置並關閉原稿外蓋。

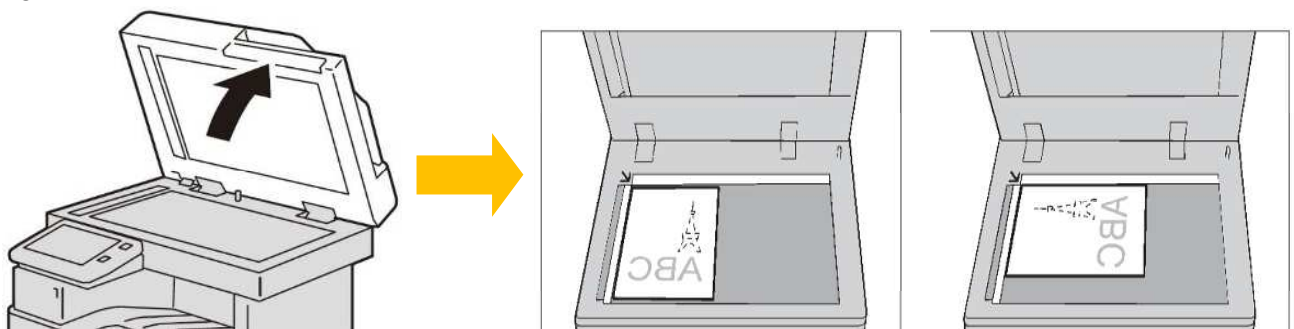

1.2 SPECIFYING DESTINATIONS 選擇指定通訊目的地

1. Press the Home button.



1. 按一下首頁按鈕。



2. Select [Fax].

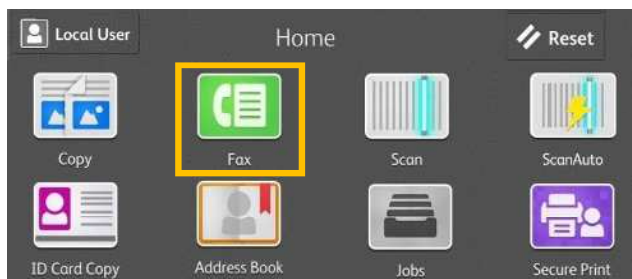

2. 選擇【傳真】。



1.2.1 Using the Numeric Keypad 使用數字鍵

1. Select [Enter Fax Number].



1. 選擇【請輸入收件人。】。





2. You can specify recipients using keyboard input.



2. 用數字鍵輸入傳真號碼。



3. If you enter an incorrect number, press the  button and re-enter the correct value.

3. 如果輸入數值錯誤，按  鍵並輸入正確數值。

4. To specify multiple recipients, select [Add] on the touch screen after each entry.

4. 若要輸入多個傳真號碼，請在顯示幕上選擇【下一對象】。

5. Select [Done] and then [Send] to start the fax job.

5. 按【完成】，然後按【送信】開始傳真工作。



1.2.2 Using the Address Book 使用電話簿

1. Select .



1. 選擇 .



2. Select the recipient numbers from [All Contacts]. Press [OK].

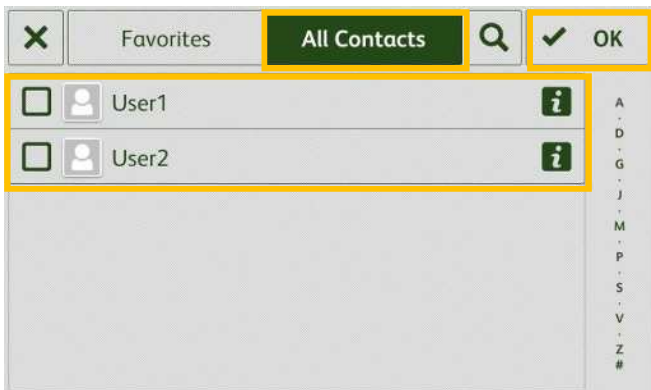

2. 按【全部】，選擇傳真號碼，然後按【OK】。



Note:

You can select multiple numbers at Step 2.

注意：

您可以在步驟 2 指定多個通信對象。

3. Press [Send] to start the fax job.



3. 按【送信】開始傳真工作。



1.2.3 Removing Specified Recipient 刪除指定的受信方

Select the recipient to delete. Press [Remove].

選擇要刪除的傳真號碼，然後按【從清單刪除】。

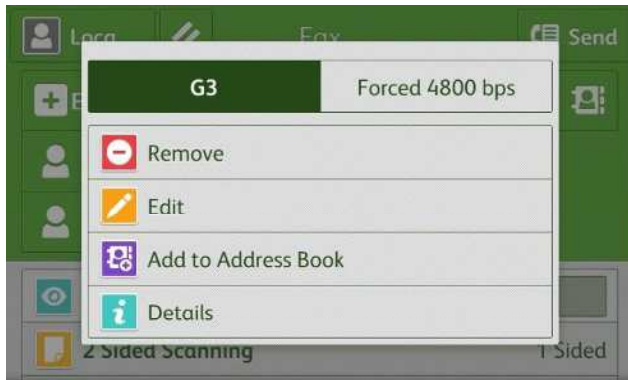

1.3 CONFIRMING THE FAX JOB IN JOB STATUS 確認傳真工作

1. Press the [Jobs] button.

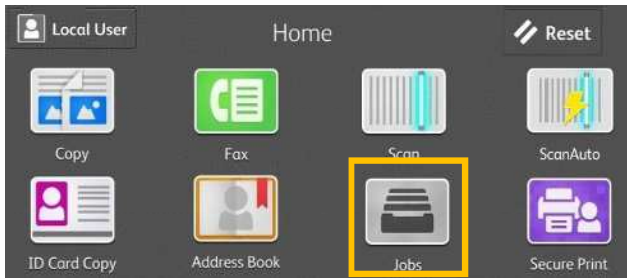

1. 按【工作確認】。



2. Confirm the job status.

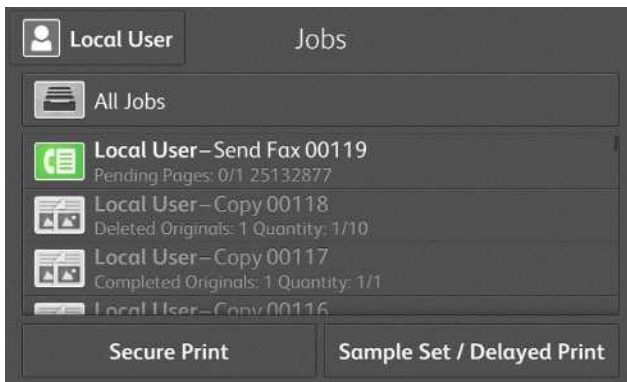

2. 確認工作狀態。



2 GENERAL SETTINGS 基本傳真

2.1 LIGHTEN/DARKEN 濃度

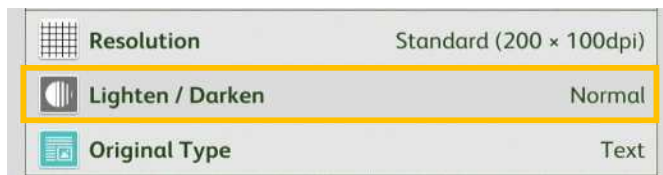

You can adjust fax density.

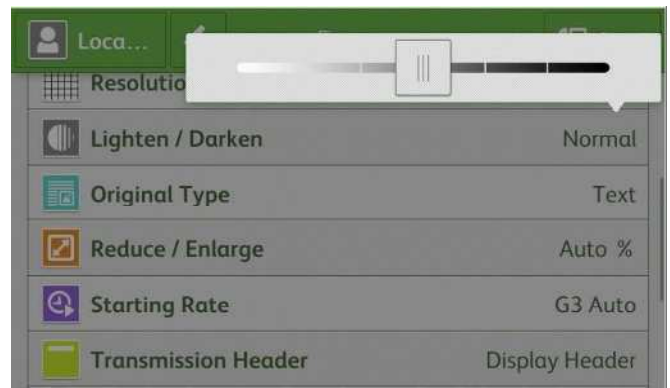

傳真濃度有七種等級選擇。

2.2 2 SIDED SCANNING 雙面原稿輸送

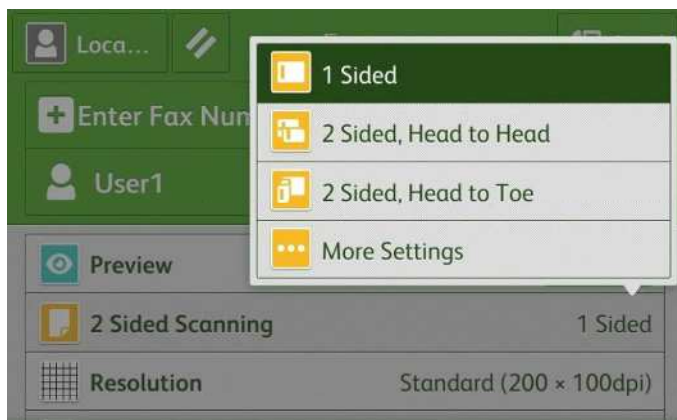
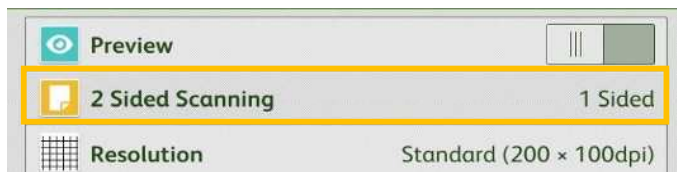

1 Sided

Select to transmit 1-sided documents.

2 Sided (Head to Head)

Select to transmit 2-sided documents (head to head).

2 Sided (Head to Toe)

Select to transmit 2-sided documents (head to toe).

→ More...

2 Sided (First Page 1 Sided)

Select this option to scan the front side of the first page and both sides of the remaining pages. Use this item when the back side of the first page is blank.

2 Sided (Skip Blank Pages)

單面

傳輸單面原稿時選擇。

雙面(左右)

傳輸雙面原稿(左右)時選擇。

雙面(上下)

傳輸雙面原稿(上下)時選擇。

→ 詳細設定

雙面(僅封面為單面)

要傳送第一張的正面及其餘張數的兩面時選擇。
若第一張的背面空白時，請用這個選項。

雙面(跳過空白頁)

2.3 ORIGINAL TYPE 原稿畫質

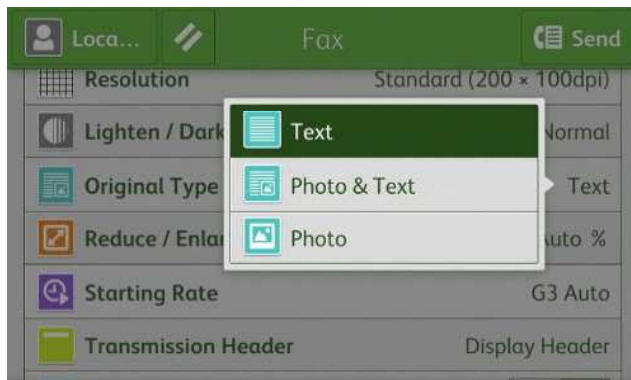

Text

Transmitting a document that contains only text.

Photo & Text

Transmitting a document that contains both text and photos.

Photo

Transmitting a document that contains only photos.

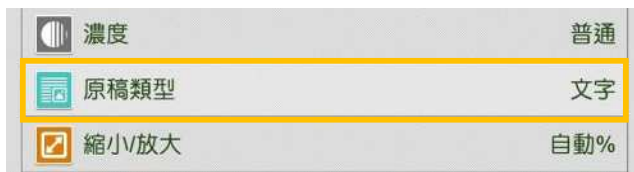

文字

傳輸僅帶有文字的原稿時選擇。

照片/文字

傳輸帶有文字及照片的原稿時選擇。

照片

傳輸僅帶有照片的原稿時選擇。

2.4 RESOLUTION 送信畫質

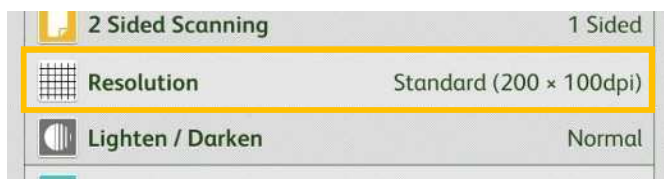

Standard (200 x 100 dpi)

Transmitting standard documents

Fine (200dpi)

Transmitting documents with small text or detailed images.

Superfine (400dpi)

Transmitting documents with fine images

Superfine (600dpi)

Transmitting documents with extremely fine images

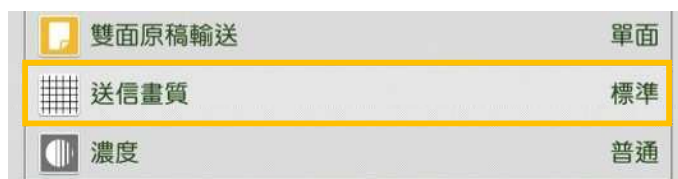

標準

傳輸文字清晰的普通原稿時選擇。

高畫質

傳輸小字及/或細緻影像原稿時選擇。

超高畫質(400 dpi)

傳輸極小字體及/或極細緻影像原稿時選擇。

超高畫質(600 dpi)

傳輸極小字體及/或極細緻影像原稿時選擇。

2.5 ACKNOWLEDGEMENT REPORT 送信確認報表

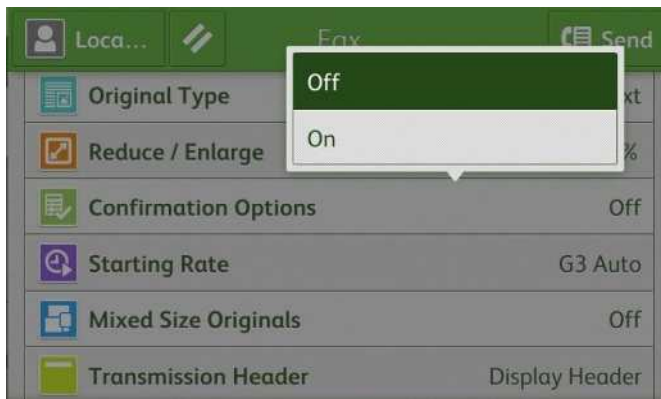
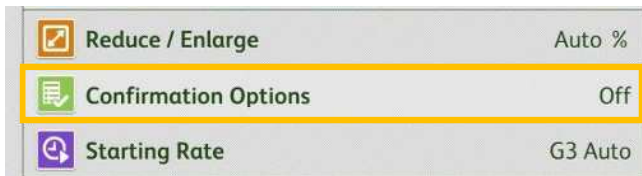

No Transmission Report is printed.



A Transmission Report is automatically printed.



不列印送信確認報表。



傳輸完成時，自動列印送信確認報表。

2.6 TRANSMISSION HEADER TEXT 發信方記錄

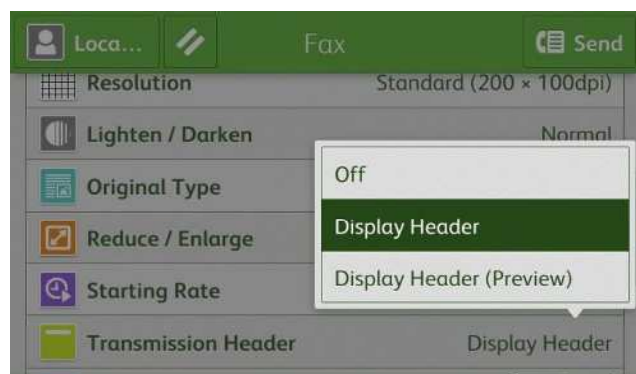

Off

No header information is attached.

Display Header

Header information is attached.

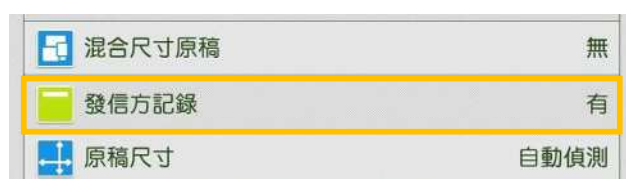

無

不附加發信方資訊。

有

附加發信方資訊。

2.7 ON-HOOK 免持聽筒

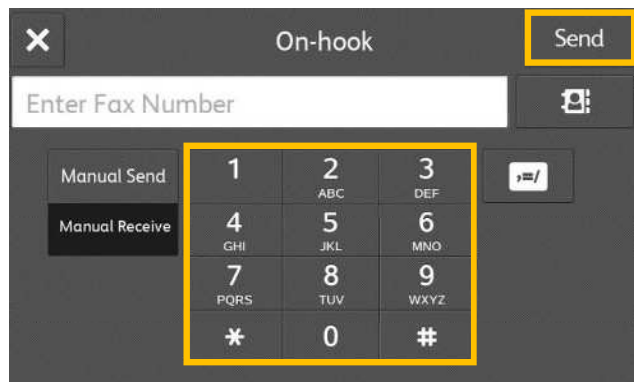

Use this feature when using Manual Send.

Entering a destination

Use alphanumeric characters to specify a destination. Then, Press the [Start] to start the fax job.

Line Cut

Cuts the line connected.



使用手動送信時，請使用此功能月已。

輸入收件人

使用英數字元指定收件人。按【啟動】開始傳真工作。

線路中斷

切斷連線。

3 OPERATIONS DURING FAXING 傳真期間的操作

3.1 STOPPING THE FAX JOB 停止傳真

1. Press [Pause] on the touch screen.

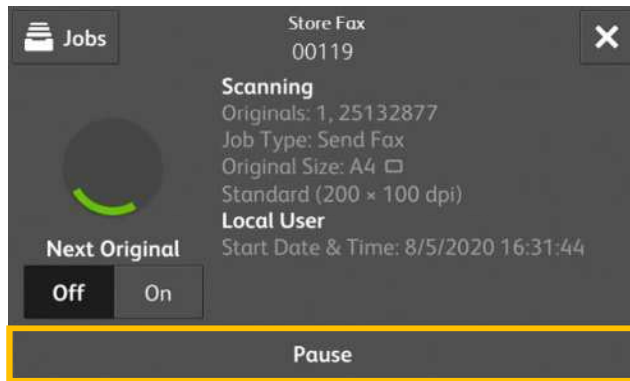

1. 按操作面板上的【停止】。

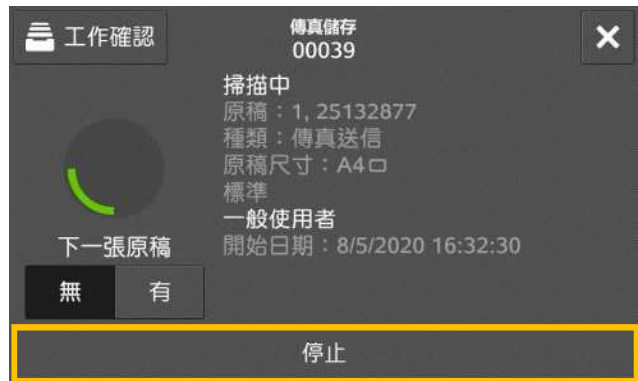

2. Select [Delete].

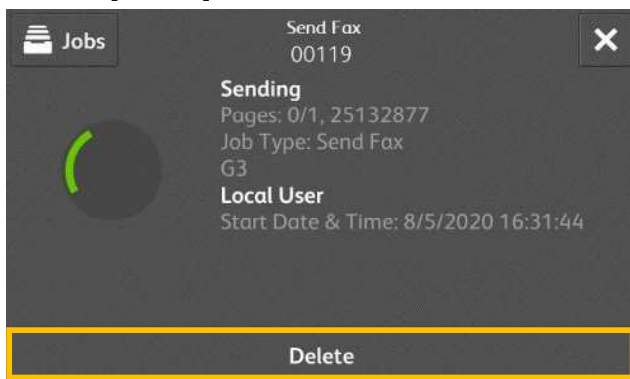

2. 按【中止】。



3. If the screen in step 1 or 2 does not appear, press the [Jobs] button.

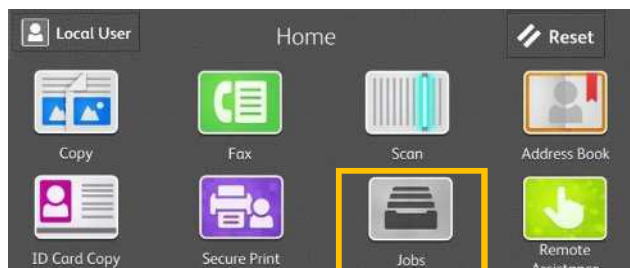

3. 若未顯示步驟 1 或 2 中的畫面，按【工作確認】。



4. Select the job to cancel.

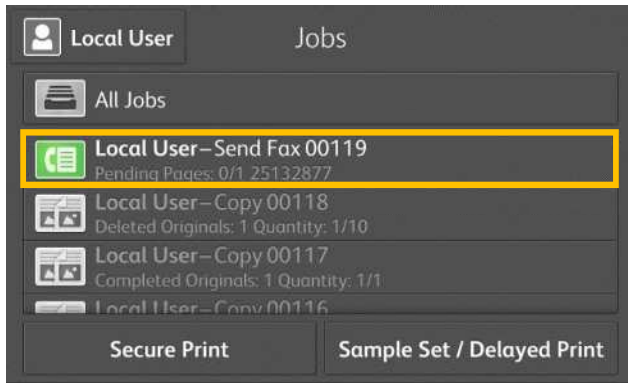

4. 選擇要取消的工作。

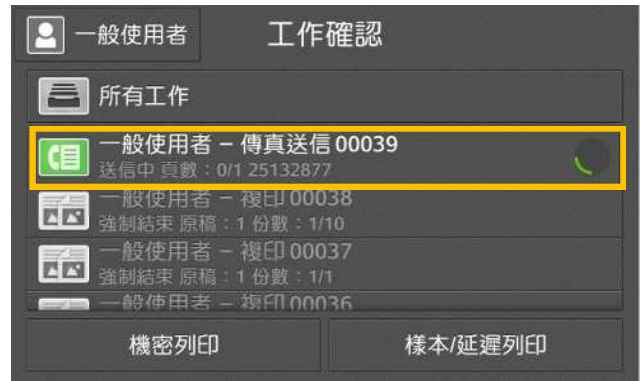

5. Select [Pause].

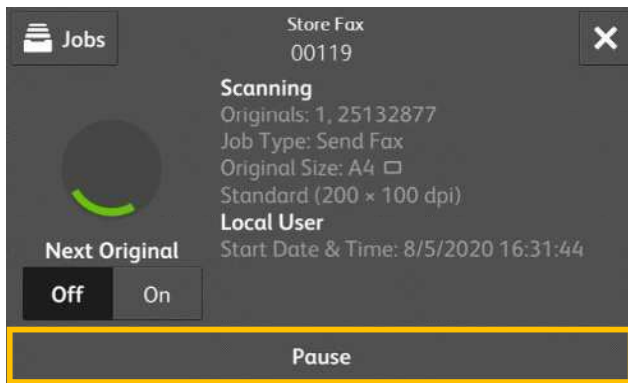

5. 選擇【暫停】。

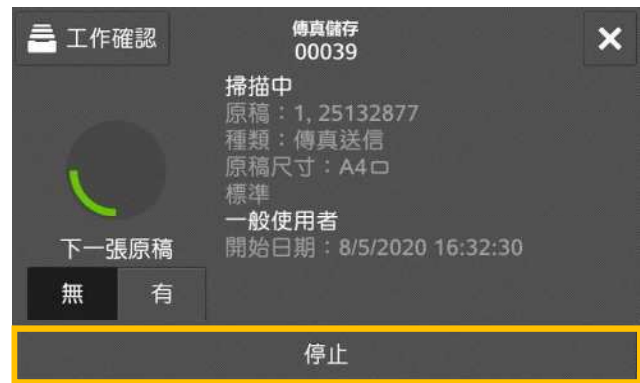

6. Select [Delete].

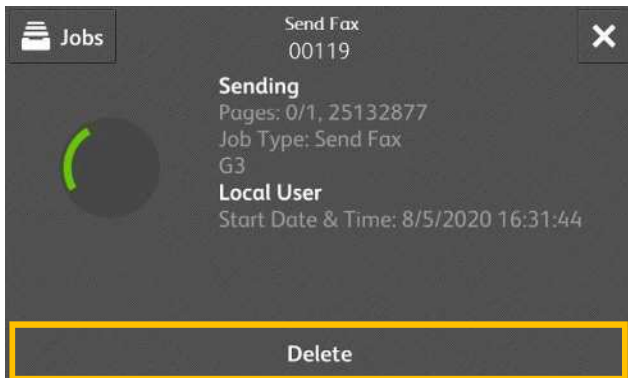

6. 選擇【中止】。



3.2 PREVIEWING THE READ IMAGES DURING A FAX JOB 傳真時預覽讀取的影像

You can preview the read images while reading the next document.

讀取下一個文件時，您可預覽之前讀取的影像。

1. When a document starts to be read with a check mark is applied to [Preview], the screen in step 3 is displayed.

1. 在【傳真】畫面勾選【預覽】的狀態下開始掃描，將顯示步驟 3 的畫面。



2. An entire preview image is displayed.
3. When all documents have been scanned, select [Send].

2. 整體顯示預覽影像。
3. 已掃描所有文件後，選擇【送信】。

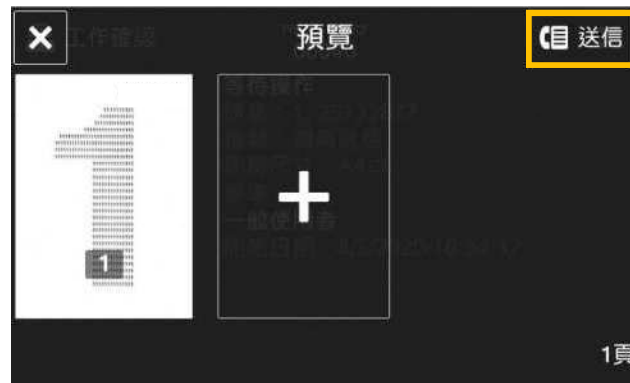
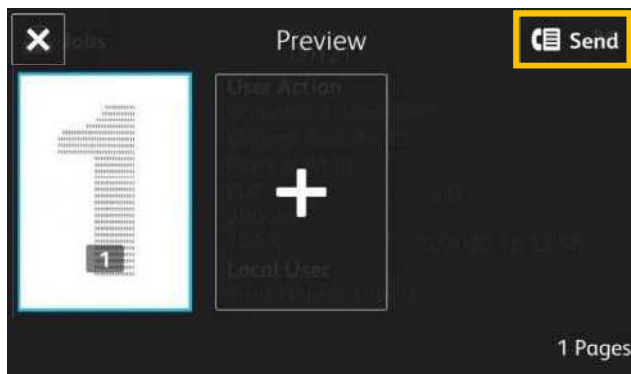

4 LOAD THE NEXT DOCUMENT 放置下一份原稿

If you have another document, select [On] on the touch screen while the current document is being scanned.

1. Select [On] while scanning is in progress.
2. Load the next document.

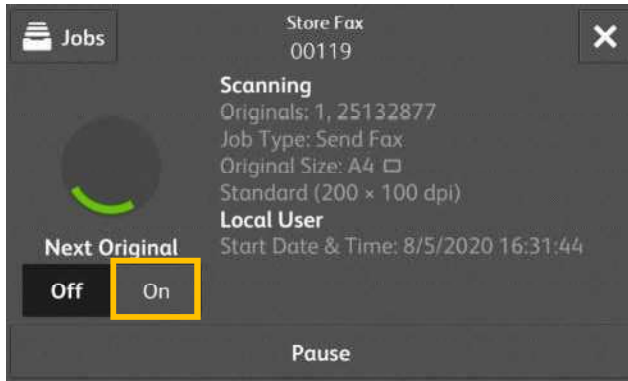

如果還有其他原稿，請在掃描原稿時，在顯示幕上選擇【有】。

1. 請在掃描進行期間選擇【有】。
2. 放入下一份原稿。



2. Press the .

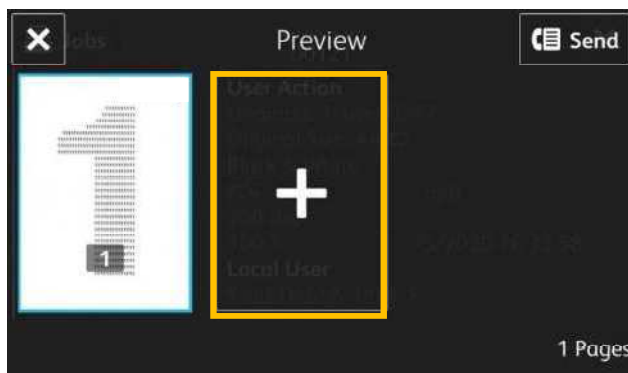

2. 按 .



3. Press [Start].

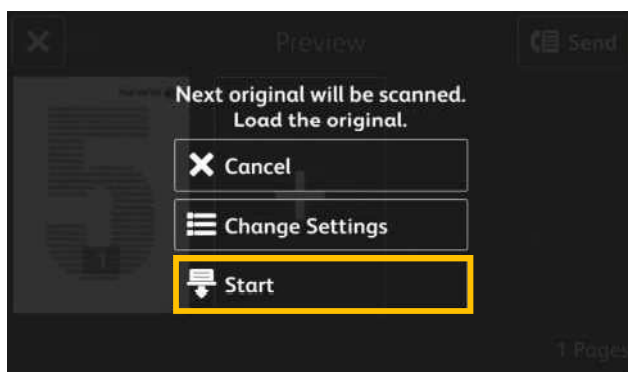

3. Press [掃描開始].



4. When all documents have been scanned, select [Send].

4. 所有原稿掃描之後，請選擇【送信】。

Customer Support Center

2513-2513